

Positive Temperature Coefficient (PTC) Data Sheet

Description

The 1812 series provides surface mount resettable overcurrent protection with holding current from 0.1A to 3.0A. This series offers complete portfolio in terms of holding current and working voltage, and is suitable for wide range of application.



Features

- RoHS compliant and lead-free
- Halogen-free
- Compact design saves board space
- Low profile
- Fast response to fault current
- Compatible with high temperature solders

Applications

- USB hubs, ports and peripherals
- Set-top-box and HDMI
- Game console port protection
- Motherboard USB & IEEE 1394 protection
- Optical disk drives
- General electronics

Agency Approval and Environmental Compliance

Agency	File Number
UL/CUL	E482628
TUV	B160696048001

Regulation	Standard
RoHS	2011/65/EU
Halogen Free	EN 14582:2007

Electrical Characteristics

Part Number	I_{hold} (A)	I_{trip} (A)	V_{max} (Vdc)	I_{max} (A)	P_d typ. (W)	Maximum Time To Trip		Resistance	
						Time (Sec.)	Current (A)	R_{min} (Ω)	R_{1max} (Ω)
SMD1812B010TF	0.10	0.30	30	100	0.8	1.50	0.50	1.600	15.000
SMD1812B014TF	0.14	0.34	60	10	0.8	0.15	1.50	1.500	6.000
SMD1812B020TF	0.20	0.40	30	100	0.8	0.02	8.00	0.800	5.000
SMD1812B020TF-J	0.20	0.40	60	40	0.8	2.00	1.00	0.700	5.000
SMD1812B035TF/30	0.35	0.75	30	40	0.8	0.15	8.00	0.400	1.700
SMD1812B050TF	0.50	1.00	15	100	0.8	0.15	8.00	0.150	1.000
SMD1812B050TF/30	0.50	1.00	30	100	0.8	0.15	8.00	0.150	1.000
SMD1812B075TF	0.75	1.50	13.2	100	0.8	0.20	8.00	0.100	0.450
SMD1812B075TF/24	0.75	1.50	24	100	0.8	0.20	8.00	0.100	0.290

Electrical Characteristics

Part Number	I_{hold} (A)	I_{trip} (A)	V_{max} (Vdc)	I_{max} (A)	$P_{d\ typ.}$ (W)	Maximum Time To Trip		Resistance	
						Time (Sec.)	Current (A)	R_{min} (Ω)	R_{1max} (Ω)
SMD1812B075TF/33	0.75	1.50	33	20	0.8	0.20	8.00	0.100	0.400
SMD1812B110TF	1.10	2.20	8	100	0.8	0.30	8.00	0.040	0.210
SMD1812B110TF/16	1.10	1.95	16	100	0.8	0.30	8.00	0.060	0.180
SMD1812B110TF/24	1.10	1.95	24	20	0.8	0.50	8.00	0.060	0.200
SMD1812B110TF/33	1.10	1.95	33	20	0.8	0.50	8.00	0.060	0.200
SMD1812B125TF/16	1.25	2.50	16	100	0.8	0.40	8.00	0.050	0.140
SMD1812B125TF/6,4L	1.25	2.50	6	100	0.8	0.40	8.00	0.050	0.140
SMD1812B150TF/8	1.50	3.00	8	100	0.8	0.30	8.00	0.040	0.120
SMD1812B150TF/12	1.50	3.00	12	100	0.8	0.50	8.00	0.040	0.120
SMD1812B150TF/16	1.50	2.80	16	100	0.8	0.50	8.00	0.040	0.120
SMD1812B150TF/24	1.50	3.00	24	20	0.8	1.50	8.00	0.040	0.120
SMD1812B160TF/8(4L)	1.60	2.8	8	100	0.8	0.30	8.00	0.030	0.100
SMD1812B160TF/16	1.60	2.80	16	100	0.8	0.80	8.00	0.030	0.100
SMD1812B200TFT	2.00	3.50	8	100	0.8	2.00	8.00	0.020	0.070
SMD1812B200TF/12	2.00	3.50	12	100	1.0	2.00	8.00	0.020	0.075
SMD1812B200TF/16	2.00	3.50	16	100	1.0	2.00	8.00	0.020	0.075
SMD1812B260TFT	2.60	5.00	8	100	0.8	2.50	8.00	0.015	0.047
SMD1812B260TF/12	2.60	5.00	12	100	0.8	5.00	8.00	0.015	0.055
SMD1812B260TF/16	2.60	5.00	16	100	1.2	5.00	8.00	0.015	0.050
SMD1812B300TFT	3.00	5.00	6	100	0.8	4.00	8.00	0.012	0.040

Note on Electrical Characteristics

■ Vocabulary

- I_{hold} = Hold current: maximum current device will pass without tripping in 23°C still air.
- I_{trip} = Trip current: minimum current at which the device will trip in 23°C still air.
- V_{max} = Maximum voltage device can withstand without damage at rated current (I_{max})
- I_{max} = Maximum fault current device can withstand without damage at rated voltage (V_{max})
- $P_{d\ typ.}$ = Typical power dissipated from device when in the tripped state at 23°C still air.
- R_{min} = Minimum resistance of device in initial (un-soldered) state.
- R_{1max} = Maximum resistance of device at 23°C measured one hour after tripping or reflow soldering of 260°C for 20 sec.

■ Value specified is determined by using the PWB with 0.030"×1.5oz copper traces.

■ Caution: Operation beyond the specified rating may result in damage and possible arcing and flame.

■ Specifications are subject to change without notice.

Polymeric PTC Selecting Guide

- Determine the following operating parameters for the circuits:
 - Normal operating current (I_{hold})
 - Maximum interrupt current (I_{max})
 - Maximum circuit voltage (V_{max})
 - Normal operating temperature surrounding device ($min^{\circ}C/max^{\circ}C$)
- Select the device from factor and dimension suitable for the application
- Compare the maximum rating for V_{max} and I_{max} of the PPTC device with the circuit in application and make sure the circuit's requirement does not exceed the device rating.
- Check that PPTC device's trip time (time-to-trip) will protect the circuit.
- Verify that the circuit operating temperature is within the PPTC device's normal operating temperature range.
- Verify that performance and suitability of the chosen PPTC device in the application.

WARNING

- Mechanical Stress
 - PPTC devices will undergo a thermal expansion during fault condition. If PPTC devices are installed or placed in an application where the space between PPTC devices and the surrounding materials (e.g., covering materials, packaging materials, encapsulate materials and the like) is insufficient, it will cause an inhibiting effect upon the thermal expansion. Pressing, twisting, berding and other kinds of mechanical stress will also adversely affect the performance of the PPTC devices, and shall not be used or applied.
- Chemical Pollutants
 - Silicone-based oils, oils, solvents, gels, electrolytes, fuels, acids, and the like will adversely affect the properties of PPTC devices, and shall not be used or applied.
- Electronic and Thermal Effect
 - PPTC devices are secondary protection devices and are used solely for sporadic, accidental over-current or over-temperature error condition, and shall NOT be used if or when constant or repeated fault conditions (such fault conditions may be caused by, among others, incorrect pin-connection of a connector) or over-extensive trip events may occur.
 - PPTC devices are different from fuses and, when a fault condition occurs, will go into high-resistance state and do not open circuit, in which case the voltage at such PPTC devices may reach a hazardous level.
 - Operation over the maximum rating or other forms of improper use may cause failure, arcing, flame and/or other damage to the PPTC devices.
 - Conductive material contamination, such as metal particle, may induce shortage, flame or arcing.
 - Due to the inductance, the operation circuits may generate a circuit voltage (Ldi/dt) above the rated voltage of PPTC devices, which shall not be used under such circumstances.
- General
 - Customers shall evaluate and test the properties of PPTC devices independently to verify and ensure that their individual applications will be met.
 - The performance of PPTC devices will be adversely affected if they are improperly used under electronic, thermal and/or mechanical procedures and/or conditions non-conformant to those recommended by manufacturer.
 - Customers shall be responsible for determining whether it is necessary to have back-up, failsafe and/or fool-proof protection To avoid or minimize damage that may result from extra-ordinary, irregular function or failure of PPTC devices.
 - Any and all responsibilities and liabilities are disclaimed if any item under this notice of warning is not complied with.

Thermal Derating Curve

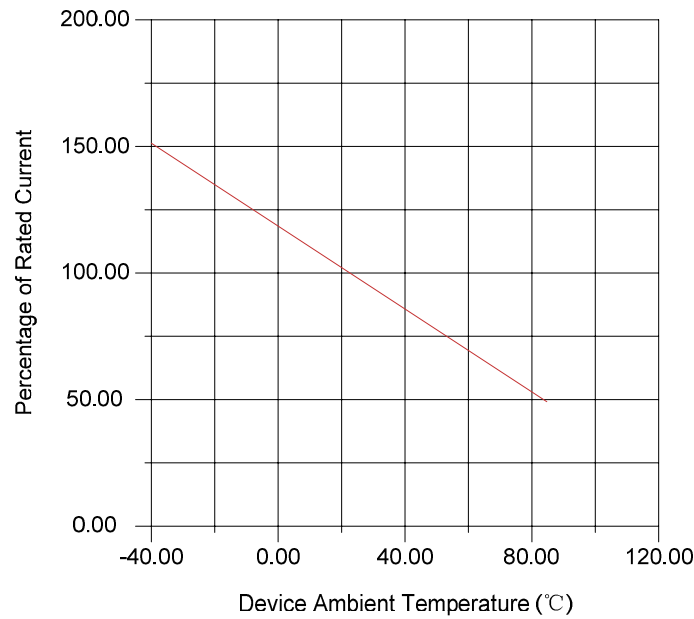

Thermal Derating Chart

Recommended Hold Current (A) at Ambient Temperature (°C)

Part Number	Ambient Operation Temperature								
	-40°C	-20°C	0°C	23°C	40°C	50°C	60°C	70°C	85°C
SMD1812B010TF	0.16	0.14	0.12	0.10	0.08	0.07	0.06	0.05	0.03
SMD1812B014TF	0.23	0.19	0.17	0.14	0.12	0.10	0.09	0.08	0.06
SMD1812B020TF	0.29	0.26	0.23	0.20	0.17	0.15	0.14	0.12	0.10
SMD1812B020TF-J	0.29	0.26	0.23	0.20	0.17	0.15	0.14	0.12	0.10
SMD1812B035TF/30	0.50	0.45	0.40	0.35	0.30	0.26	0.24	0.20	0.16
SMD1812B050TF	0.77	0.68	0.59	0.50	0.44	0.40	0.37	0.33	0.29
SMD1812B050TF/30	0.77	0.68	0.59	0.50	0.44	0.40	0.37	0.33	0.29
SMD1812B075TF	1.15	1.01	0.88	0.75	0.65	0.60	0.55	0.49	0.43
SMD1812B075TF/24	1.06	0.95	0.84	0.75	0.60	0.55	0.50	0.45	0.37
SMD1812B075TF/33	1.10	1.00	0.88	0.75	0.66	0.60	0.56	0.47	0.36
SMD1812B110TF	1.59	1.43	1.26	1.10	0.95	0.87	0.80	0.71	0.60
SMD1812B110TF/16	1.58	1.43	1.27	1.10	0.95	0.85	0.77	0.71	0.58
SMD1812B110TF/24	1.55	1.40	1.25	1.10	0.93	0.83	0.73	0.63	0.50
SMD1812B110TF/33	1.55	1.40	1.25	1.10	0.93	0.83	0.73	0.63	0.50
SMD1812B125TF/16	2.00	1.75	1.52	1.25	1.00	0.95	0.90	0.75	0.53
SMD1812B125TF/6,4L	2.00	1.75	1.52	1.25	1.00	0.95	0.90	0.75	0.53
SMD1812B150TF/8	2.06	1.93	1.79	1.50	1.28	1.10	1.02	0.80	0.68
SMD1812B150TF/12	2.04	1.88	1.68	1.50	1.25	1.10	1.00	0.80	0.60

SMD1812 SERIES

Part Number	Ambient Operation Temperature								
	-40°C	-20°C	0°C	23°C	40°C	50°C	60°C	70°C	85°C
SMD1812B150TF/16	2.04	1.88	1.68	1.50	1.25	1.10	1.00	0.80	0.60
SMD1812B150TF/24	2.05	1.87	1.67	1.50	1.25	1.08	0.95	0.77	0.60
SMD1812B160TF/8(4L)	2.20	2.06	1.91	1.60	1.36	1.17	1.09	0.85	0.72
SMD1812B160TF/16	2.20	2.06	1.91	1.60	1.36	1.17	1.09	0.85	0.72
SMD1812B200TFT	2.60	2.44	2.22	2.00	1.78	1.67	1.50	1.45	1.29
SMD1812B200TF/12	2.60	2.44	2.22	2.00	1.78	1.67	1.50	1.45	1.29
SMD1812B200TF/16	2.60	2.44	2.22	2.00	1.78	1.67	1.50	1.45	1.29
SMD1812B260TFT	3.40	3.16	3.00	2.60	2.30	2.15	2.00	1.85	1.63
SMD1812B260TF/12	3.40	3.16	3.00	2.60	2.30	2.15	2.00	1.85	1.63
SMD1812B260TF/16	3.40	3.16	3.00	2.60	2.30	2.15	2.00	1.85	1.63
SMD1812B300TFT	4.13	3.75	3.30	3.00	2.62	2.43	2.25	2.00	1.78

Average Time-Current Curve

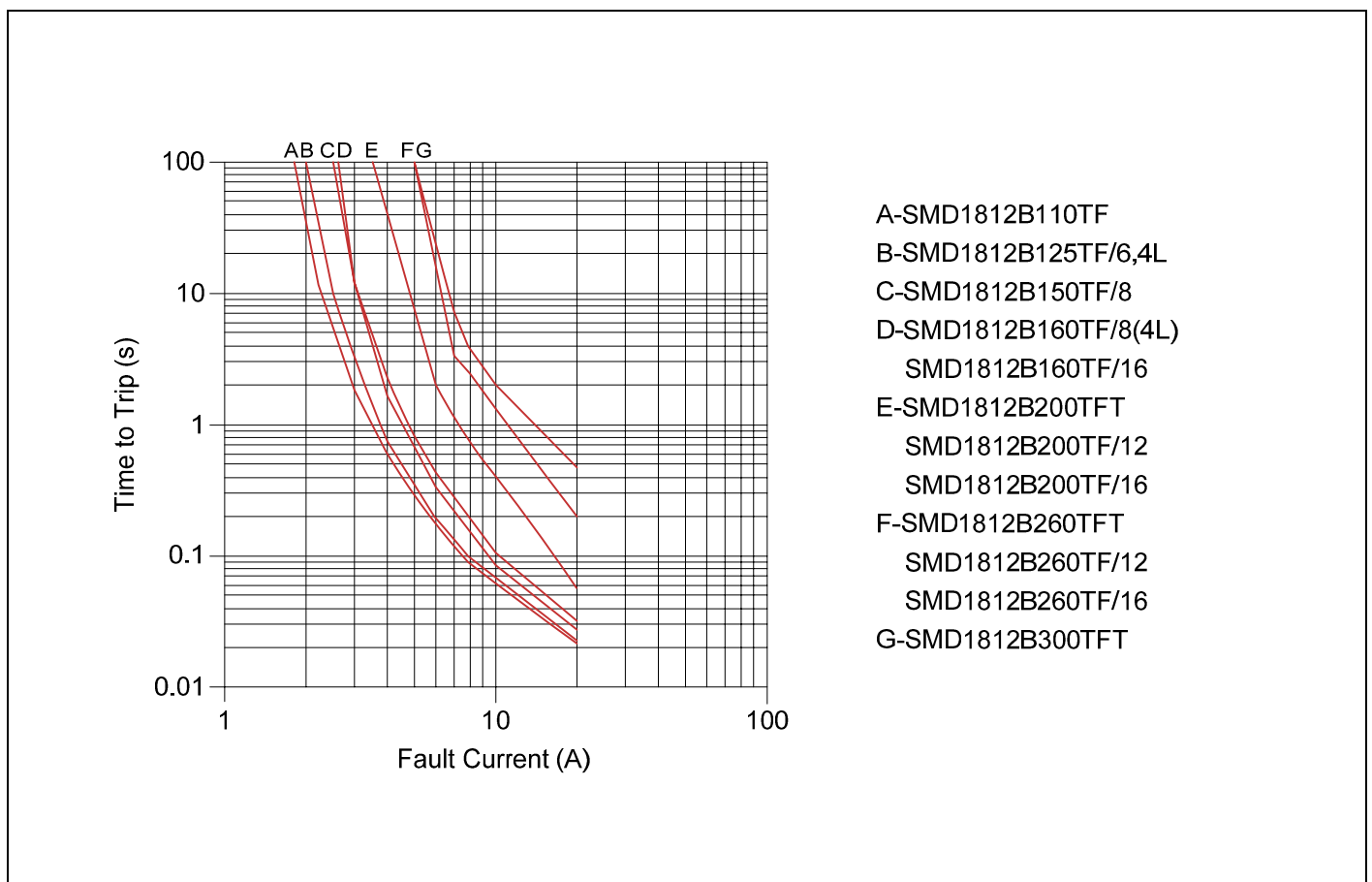

SMD1812 SERIES

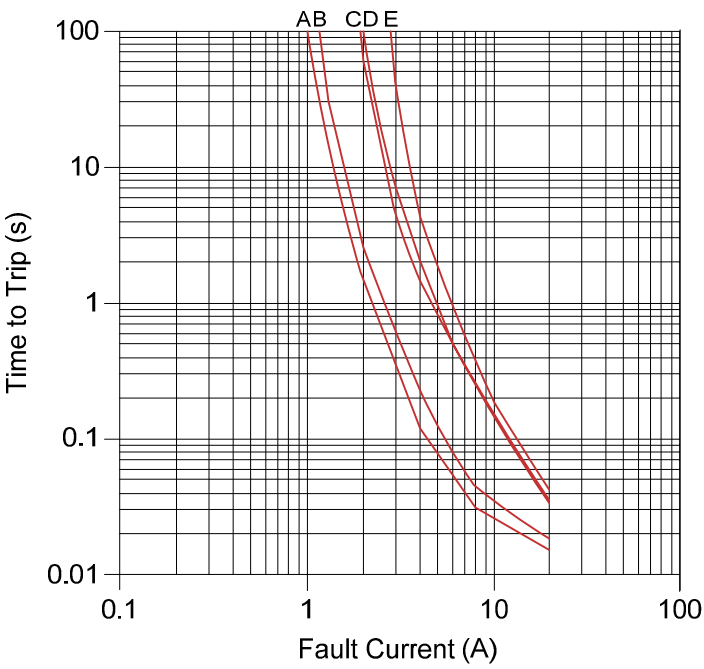

- A-SMD1812B050TF
- B-SMD1812B075TF
- C-SMD1812B110TF/16
- D-SMD1812B125TF/16
- E-SMD1812B150TF/12
- SMD1812B150TF/16

Average Time-Current Curve

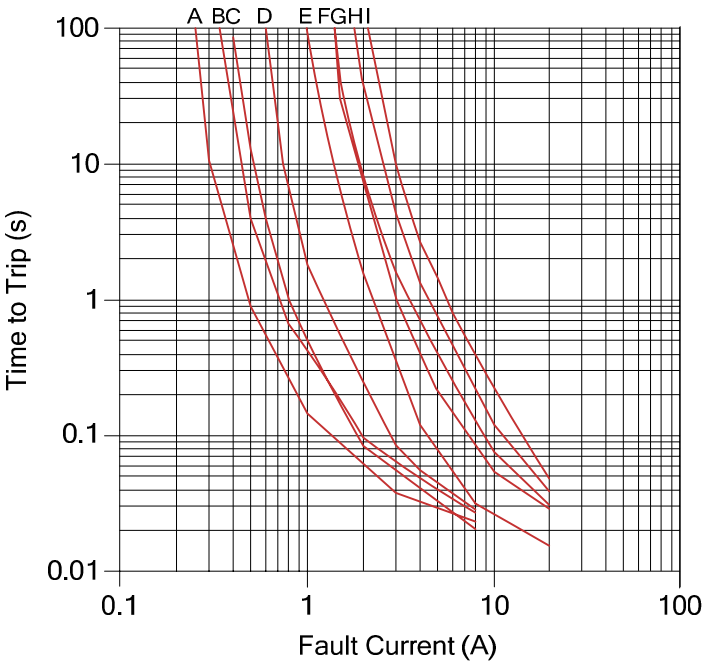

- A-SMD1812B010TF
- B-SMD1812B014TF
- C-SMD1812B020TF
- SMD1812B020TF-J
- D-SMD1812B035TF/30
- E-SMD1812B050TF/30
- F-SMD1812B075TF/33
- G-SMD1812B075TF/24
- H-SMD1812B110TF/24
- I-SMD1812B150TF/24

Soldering Parameters

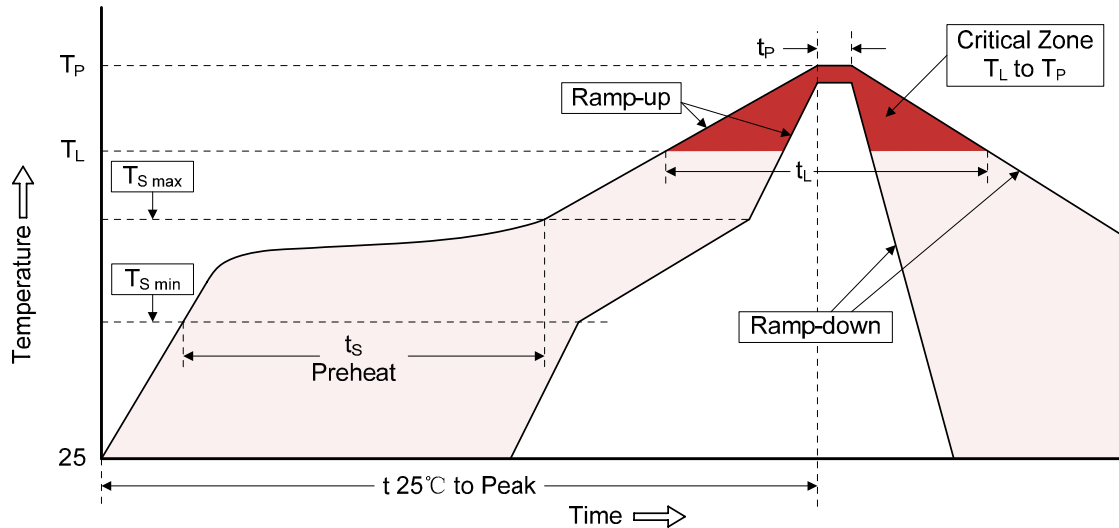

Profile Feature	Pb-Free Assembly
Average ramp-up rate ($T_{S\ max}$ to T_P) °C	3 /second max.
Preheat -Temperature Min ($T_{S\ min}$) -Temperature Max ($T_{S\ max}$) -Time (min to max) ($T_{S\ min}$ to $T_{S\ max}$)	150°C 200°C 60-180 seconds
Time maintained above: -Temperature (T_L) -Time (t_L)	217°C 60-150 seconds
Peak Temperature (T_P)	260°C
Time within 5°C of actual Peak Temperature (t_p)	20-40 seconds
Ramp-down Rate °C	6 /second max.
Time 25°C to Peak Temperature	8 minutes max.
Storage Condition	0°C~35°C, ≤70%RH

- Recommended reflow methods: IR, vapor phase oven, hot air oven, N₂ environment for lead-free
- Recommended maximum paste thickness is 0.25mm (0.010 inch)
- Device can be cleaned using standard industry methods and solvents.

Note 1: All temperature refer to topside of the package, measured on the package body surface.

Note 2: If reflow temperatures exceed the recommended profile, devices may not meet the performance requirements.

Physical Dimensions (mm)

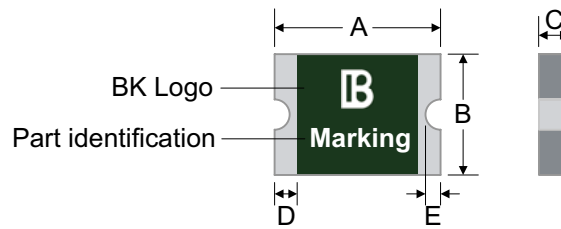

Part Number	A		B		C		D		E	
	Min.	Max.	Min.	Max.	Min.	Max.	Min.	Max.	Min.	Max.
SMD1812B010TF	4.37	4.73	3.07	3.41	0.75	1.25	0.30	1.20	0.15	0.65
SMD1812B014TF	4.37	4.73	3.07	3.41	0.75	1.95	0.30	1.20	0.15	0.65
SMD1812B020TF	4.37	4.73	3.07	3.41	0.55	1.25	0.30	1.20	0.15	0.65
SMD1812B020TF-J	4.37	4.73	3.07	3.41	0.55	1.25	0.30	1.20	0.15	0.65
SMD1812B035TF/30	4.37	4.73	3.07	3.41	0.55	1.25	0.30	1.20	0.15	0.65
SMD1812B050TF	4.37	4.73	3.07	3.41	0.50	1.25	0.30	1.20	0.15	0.50
SMD1812B050TF/30	4.37	4.73	3.07	3.41	0.50	2.10	0.30	1.20	0.15	0.65
SMD1812B075TF	4.37	4.73	3.07	3.41	0.50	1.55	0.30	1.20	0.15	0.50
SMD1812B075TF/24	4.37	4.73	3.07	3.41	0.50	1.55	0.30	1.20	0.15	0.65
SMD1812B075TF/33	4.37	4.73	3.07	3.41	0.75	1.55	0.30	1.20	0.15	0.65
SMD1812B110TF	4.37	4.73	3.07	3.41	0.30	2.00	0.30	1.20	0.15	0.65
SMD1812B110TF/16	4.37	4.73	3.07	3.41	0.30	2.00	0.30	1.20	0.15	0.65
SMD1812B110TF/24	4.37	4.73	3.07	3.41	0.30	2.00	0.30	1.20	0.15	0.65
SMD1812B110TF/33	4.37	4.73	3.07	3.41	0.75	2.00	0.30	1.20	0.15	0.65
SMD1812B125TF/16	4.37	4.73	3.07	3.41	0.45	1.50	0.30	1.20	0.15	0.65
SMD1812B125TF/6,4L	4.37	4.73	3.07	3.41	0.45	1.50	0.30	1.20	0.15	0.65
SMD1812B150TF/8	4.37	4.73	3.07	3.41	0.40	0.90	0.30	1.20	0.15	0.65
SMD1812B150TF/12	4.37	4.73	3.07	3.41	0.40	1.80	0.30	1.20	0.15	0.65
SMD1812B150TF/16	4.37	4.73	3.07	3.41	0.40	1.80	0.30	1.20	0.15	0.65
SMD1812B150TF/24	4.37	4.73	3.07	3.41	0.80	2.10	0.30	1.20	0.15	0.65
SMD1812B160TF/8(4L)	4.37	4.73	3.07	3.41	0.40	1.80	0.30	1.20	0.15	0.65
SMD1812B160TF/16	4.37	4.73	3.07	3.41	0.75	1.80	0.30	1.20	0.15	0.65
SMD1812B200TFT	4.37	4.73	3.07	3.41	0.20	1.25	0.30	1.20	0.15	0.65
SMD1812B200TF/12	4.37	4.73	3.07	3.41	0.80	1.80	0.30	1.20	0.15	0.65
SMD1812B200TF/16	4.37	4.73	3.07	3.41	0.80	2.00	0.30	1.20	0.15	0.65
SMD1812B260TFT	4.37	4.73	3.07	3.41	0.20	1.80	0.30	1.20	0.15	0.65
SMD1812B260TF/12	4.37	4.73	3.07	3.41	0.80	1.80	0.30	1.20	0.15	0.65
SMD1812B260TF/16	4.37	4.73	3.07	3.41	0.80	2.10	0.30	1.20	0.15	0.65
SMD1812B300TFT	4.37	4.73	3.07	3.41	0.50	1.60	0.30	1.20	0.15	0.65

Environmental Specifications

Operating / Storage temperature	-40°C to +85°C
Maximum Device Surface Temperature in Tripped State	125°C
Passive Aging	+85°C, 1000 hours ±50% typical resistance change
Humidity Aging	+85°C, 85%R.H. 1000 hours ±50% typical resistance change
Thermal Shock	MIL-STD-202, Method 107G +85°C/-40°C 20 times -50% typical resistance change
Solvent Resistance	MIL-STD-202, Method 215 No change
Vibration	MIL-STD-883C, Method 2007.1, Condition A No change
Moisture Level Sensitivity	Level 1, J-STD-020C

Packaging Quantity and Marking

Recommended Pad Layout (mm)

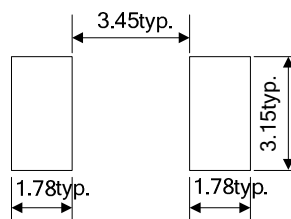

Part Number	Marking	Quantity
SMD1812B010TF	010	1500
SMD1812B014TF	014	1500
SMD1812B020TF	020	1500
SMD1812B020TF-J	020.J	1500
SMD1812B035TF/30	0330	2000
SMD1812B050TF	050	2000
SMD1812B050TF/30	0530	1000
SMD1812B075TF	075	2000
SMD1812B075TF/24	0724	1500
SMD1812B075TF/33	0733	1000

Packaging Quantity and Marking

Recommended Pad Layout (mm)

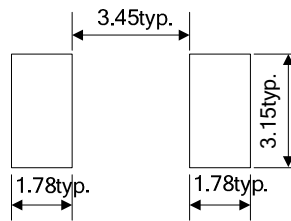

Part Number	Marking	Quantity
SMD1812B110TF	110	2000
SMD1812B110TF/16	1116	1500
SMD1812B110TF/24	1124	1000
SMD1812B110TF/33	1133	1000
SMD1812B125TF/16	125	1500
SMD1812B125TF/6,4L	125	2000
SMD1812B150TF/8	150	2000
SMD1812B150TF/12	1512	1500
SMD1812B150TF/16	1516	1000
SMD1812B150TF/24	1524	1000
SMD1812B160TF/8(4L)	160	2000
SMD1812B160TF/16	1616	1000
SMD1812B200TFT	20	2000
SMD1812B200TF/12	2012	1000
SMD1812B200TF/16	2016	1000
SMD1812B260TFT	260	2000
SMD1812B260TF/12	2612	1000
SMD1812B260TF/16	2616	1000
SMD1812B300TFT	30	1000

© 12mm tape on 7 inch reel per EIA-481 (equivalent to IEC286, part 3)

Physical Specifications

Terminal Material	Solder-Plated Copper (Solder Material: Matte Tin (Sn))
Lead Solderability	Meets EIA Specification RS186-9E, ANSI/J-STD-002 Category 3.

Packaging

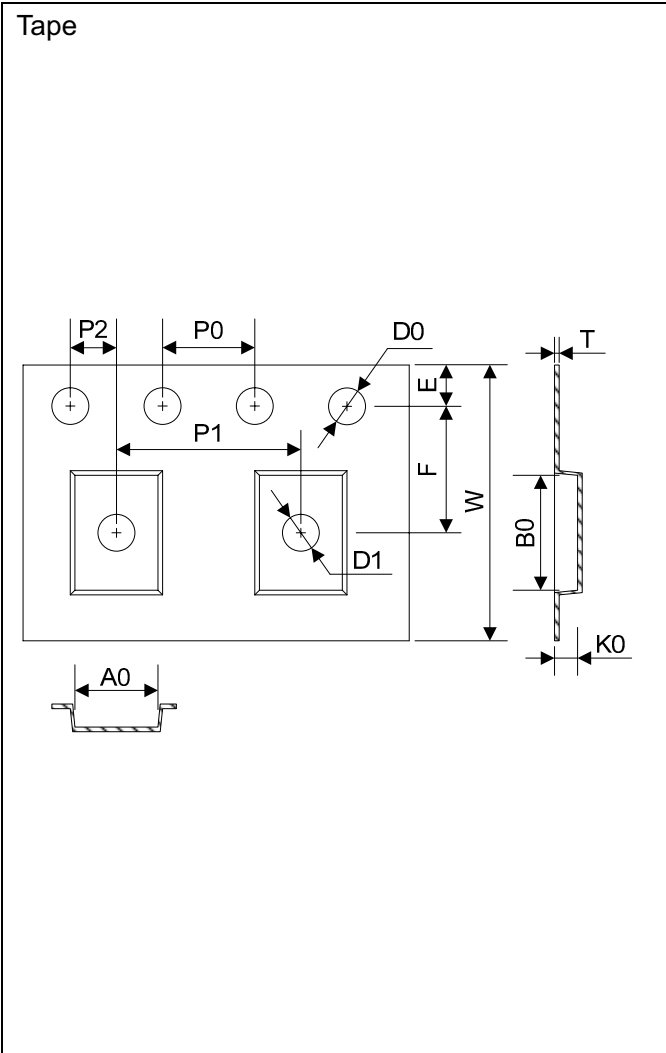

Symbol	Dimensions (mm)		
	B035TF/30 B050TF B075TF B110TF B125TF/6,4L B150TF/8 B160TF/8(4L) B200TFT, B260TFT	B010TF B014TF B020TF B020TF-J B075TF/24 B110TF/16 B125TF/16 B150TF/12	B050TF/30, B075TF/33 B110TF/24, B110TF/33 B150TF/16, B150TF/24 B160TF/16 B200TF/12, B200TF/16 B200TF/12, B200TF/16 B260TF/12, B260TF/16 B300TFT
W	12.00±0.30	12.00±0.30	12.00±0.10
F	5.50±0.05	5.50±0.05	5.50±0.05
E	1.75±0.10	1.75±0.10	1.75±0.10
D0	1.55±0.05	1.55±0.05	1.55±0.05
D1	1.55(MIN)	1.50±0.10	1.55(MIN)
P0	4.00±0.10	4.00±0.10	4.00±0.10
P1	8.00±0.10	8.00±0.10	8.00±0.10
P2	2.00±0.05	2.00±0.05	2.00±0.05
A0	3.58±0.10	3.50±0.10	3.58±0.10
B0	4.93±0.10	4.85±0.10	4.93±0.10
T	0.25±0.10	0.25±0.10	0.25±0.10
K0	0.87±0.10	1.25±0.10	2.10±0.10
Leader min.	390	390	390
Trailer min.	160	160	160

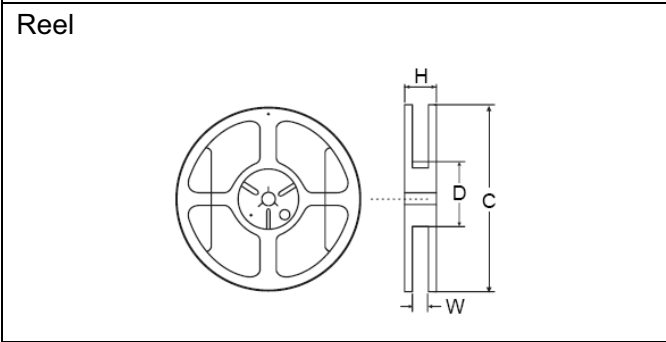

C	Φ178.0±1.0
D	Φ60.2±0.5
H	16.0±0.5
W	13.2±1.5

Part Number System

SMD 1812 B TF T /

