



A系列 B4

密封处理
0.4VA微小功率
直型、直角型、以及垂直型PC端子



CW系列 B12

6A大功率
焊片焊接、快速连接和直角型PC端子
嵌入式安装



CWSB系列照明开关 B18

氖灯；9A大功率
快速连接；嵌入式安装



CWSC系列照明开关 B22

LED；9A大功率
焊片/快速连接；嵌入式安装



G系列 B28

密封处理
0.4VA微小功率
直型PC端子



GW系列 B32

超小巧
0.4VA微小功率
直型、直角型、以及垂直型PC端子



GW系列照明开关 B36

全发光手柄开关
0.4VA微小功率
直型、直角型、以及垂直型PC端子



JW系列 B40

国际认证
10A和16A大功率
焊片；嵌入式安装



JWS系列照明和非照明开关 B50

国际认证
10A大功率
焊片；嵌入式安装



LW系列照明开关 B56

10A大功率
白炽灯双灯
焊片；嵌入式安装



M系列 B62

嵌入式安装
6A大功率和0.4VA微小功率
焊片焊接、快速连接、直型PC端子、以及绕线



M系列 B72

配有支架的PC端子安装
6A大功率和0.4VA微小功率
配有支架的直型、直角型、以及垂直型PC端子

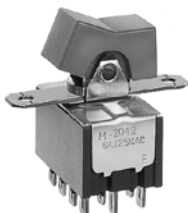

M系列 B83

扁平框架安装
6A大功率和0.4VA微小功率
焊片焊接和直型PC端子



M2100系列照明开关 B92

6A大功率和0.4VA微小功率
焊片、快速连接、以及印刷电路端子
扁平框架和嵌入式安装



M2T系列 B98

密封处理
6A大功率和0.4VA微小功率
直型、直角型、以及垂直型PC端子



MLW系列照明开关 B106

5A大功率
白炽灯、氖灯、以及LED灯
焊片；嵌入式安装



P系列 B114

国际认证
10A大功率
焊片焊接、直型PC端子、以及快速连接；扁平框架安装

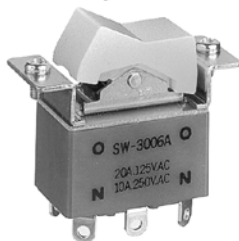

SW系列 B120

15A到30A中、大容量
焊片焊接和螺丝端子
螺丝安装



WR系列 B124

环境密封
15A大功率
焊片、螺丝、引线、以及快速连接
嵌入式安装

通用规格

摇头开关

翘板开关
B

按钮开关

发光按钮开关

可编程开关

钥匙锁开关

旋转开关

滑动开关

触觉开关

倾斜开关

触觉开关

指示灯

附件

附录

电气容量 (电阻性负载)

微小功率: 最大0.4VA在最高28V AC/DC
(适用范围0.1mA~0.1A在20mV~28V)
注: 请参阅附录中关于运行范围的更多说明。

其他额定参数

触点电阻: 最大50毫欧
绝缘电阻: 500兆欧以上在500V DC
绝缘强度: 500V AC以上至少1分钟
机械寿命: 100,000次操作以上对于On-None-On和On-Off-On
50,000次操作以上对于其他电路
电气寿命: 50,000次操作以上
标称操作力: 2.73N(瞬间); 1.84N(持续)
接触时间点: 无短路(接触前先断开)
摆动角度: 26°

材质和涂覆

操作部或摇杆: 黄铜镀镍
外壳: 玻璃纤维增强聚酰胺
支撑支架: 镀锡磷青铜
活动触点: 磷青铜镀金
固定触点: 黄铜镀金
端子: 黄铜镀金

环境数据

工作温度范围: -30°C到+85°C (-22°F到+185°F)
湿度: 240小时内40°C (104°F)时, 湿度90~95%
振动: 用1.5mm峰-峰振幅遍历10~55Hz频率范围, 并在1分钟内返回; 3个直角方向2小时
冲击: 50G (490m/s²) 加速度(在6个直角方向上测试, 每个方向上5次冲击)

安装

盖帽安装力: 最大39.23N (8.82 lbf)向下施加在操作部上

印刷电路板处理

焊接: 推荐波峰焊: 请参阅附录中的概略图A。
手工焊接: 请参阅附录中的概略图B。
清洗: 自动清洗。请参阅附录中的清洗规格。

标准和认证

A系列翘板开关未经过UL认证测试或CSA认证测试。
这些开关为在低电压、低电流、微小功率电路中使用而设计。
当按原意图用于微小电流电路时, 其结果不会产生危险的能量。

主要特点

超小尺寸节省印刷电路板空间。

专为微小电流电路应用而设计。

全封闭结构防止触点污染并能自动焊接和清理从而节省时间和费用。

获奖的STC触点机构具有传统触点机构所不具备的如下优点：更加平滑、制动更可靠、接触稳定性更高、以及无与伦比的微小功率可靠性。（关于STC的术语和缩写的详情，请参阅附录目录。）

环氧树脂密封注塑端子或超声波焊接的端子可阻止熔融物、溶剂、以及其他污染物侵入。

.100" x .100" (2.54mm x 2.54mm) 端子间距符合标准印刷电路板的格子间距。

与本开关相适配的指示灯可供选择。

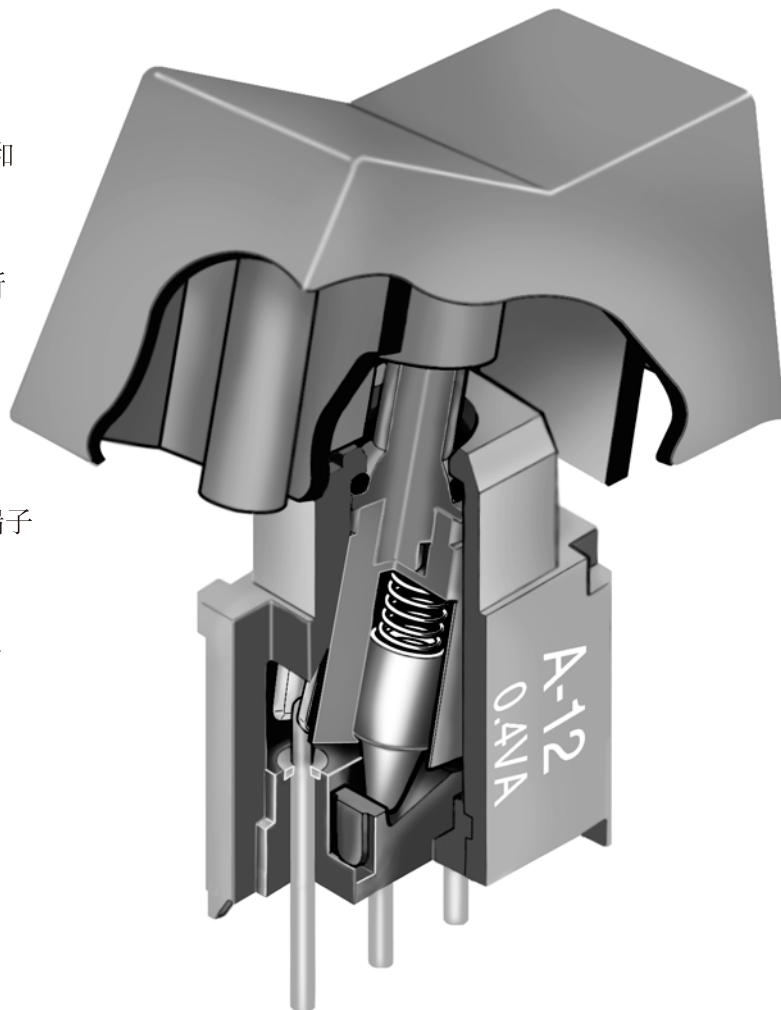

实际尺寸

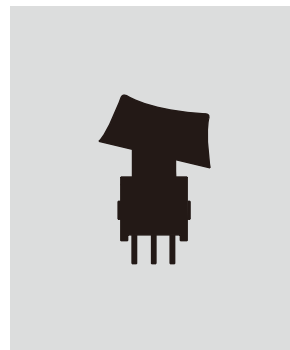

摇头开关

B 翘板开关

按钮开关

发光按钮开关

可编程开关

钥匙锁开关

旋转开关

滑动开关

触觉开关

倾斜开关

触觉开关

指示灯

附件

附录

典型开关订购举例

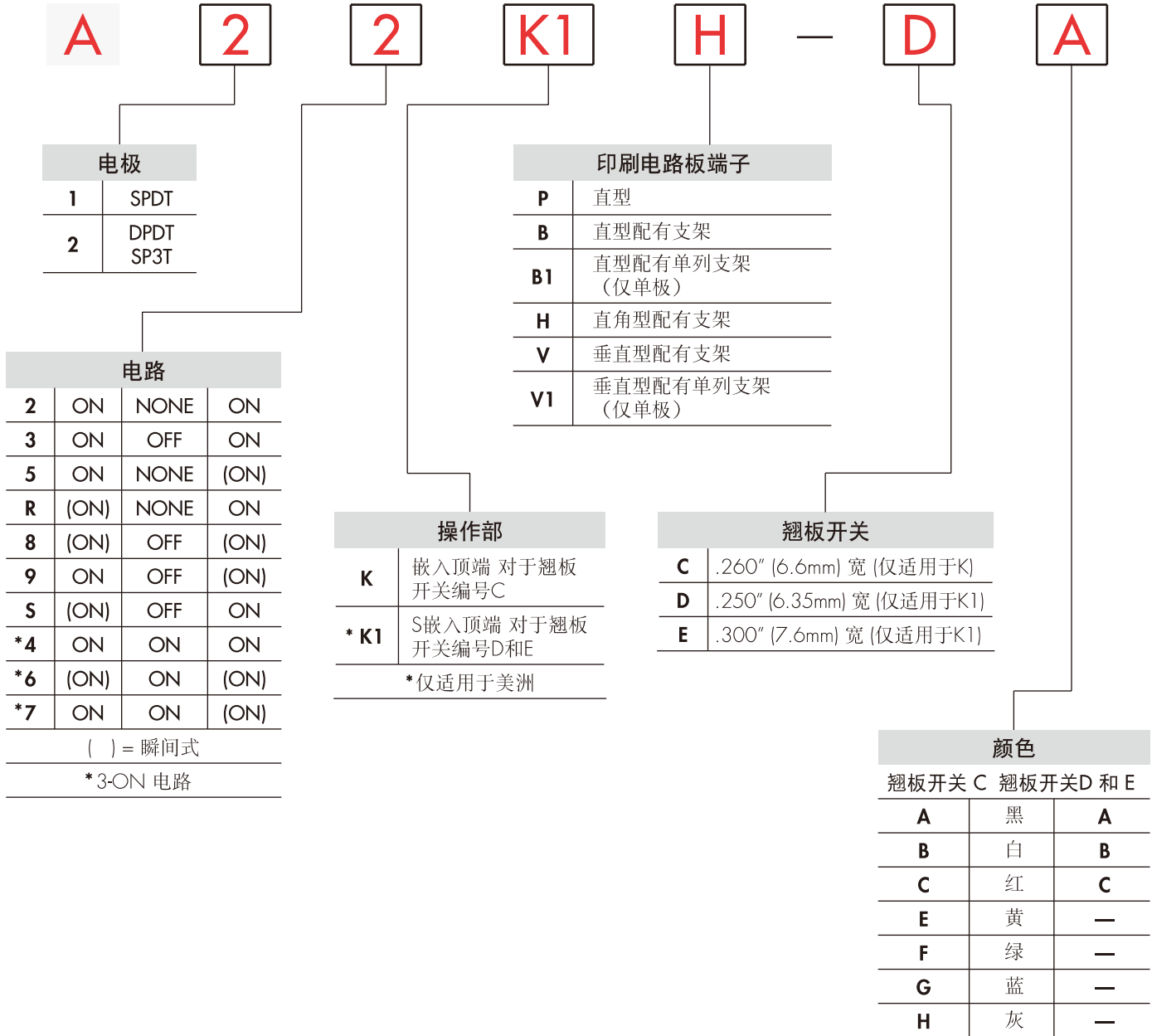

典型订购举例

A22K1H-DA

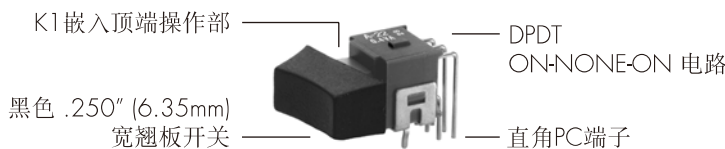

电极和电路

		翘板位置 () = 瞬间式			连接的端子			投掷及其示意图
电极	型号	上	中	下	上	中	下	
								注: 端子编号并未实际印制在开关上
SP	A12 A13 A15 A1R A18 A19 A1S	ON ON ON (ON) (ON) ON (ON)	NONE OFF NONE NONE OFF OFF OFF	ON ON (ON) ON (ON) (ON) ON	2-3	OPEN	2-1	SPDT
DP	A22 A23 A25 A2R A28 A29 A2S	ON ON ON (ON) (ON) ON (ON)	NONE OFF NONE NONE OFF OFF OFF	ON ON (ON) ON (ON) (ON) ON	2-3 5-6	OPEN	2-1 5-4	DPDT

对于3掷 (3-On)

连接的端子和示意图					外部连接
电极	型号	上	中	下	
SP	A24 A26 A27	ON (ON) ON 2-3 5-6	ON ON ON 2-3 5-4	ON (ON) (ON) 2-1 5-4	SP3T型使用双极基座。 在现场安装时必须进行外部连接。

操作部



对于翘板开关AT469

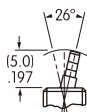

对于翘板开关
AT062和AT066

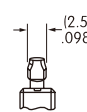
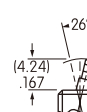
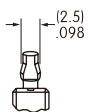

印刷电路板端子

建议使用支撑支架以增加印刷电路板安装强度和稳定性。

P 直型

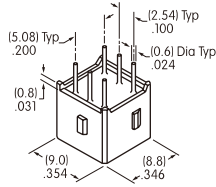

B 直型配有支架

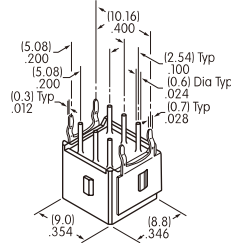

B1 直型配有单列支架
仅单极

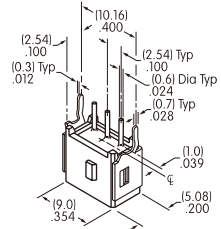

H 直角型配有支架

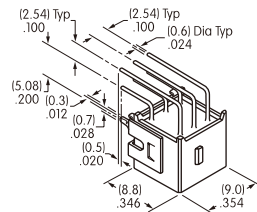

V 垂直型配有支架

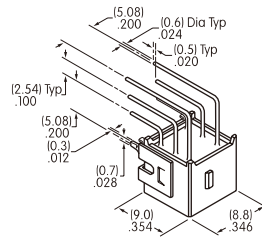

V1 垂直型配有单列支架
仅单极

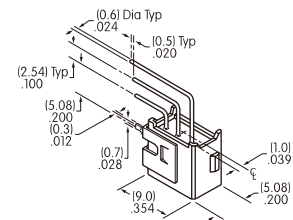

翘板及其颜色

C AT469
.260" (6.6mm) 宽翘板

防转动
材质: 聚酰胺
可供选择的颜色:
A, B, C, E, F, G, H

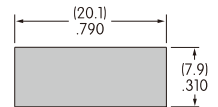
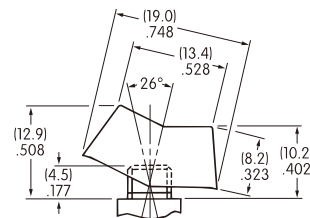
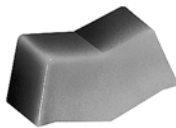

D AT062
.250" (6.35mm) 宽翘板

防转动
材质: 聚酰胺
可供选择的颜色:
A, B, C

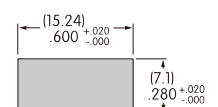
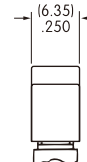
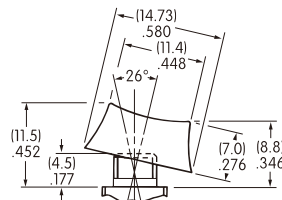
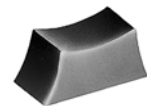

E AT066
.300" (7.6mm) 宽翘板

防转动
材质: 聚酰胺
可供选择的颜色:
A, B, C

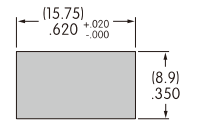
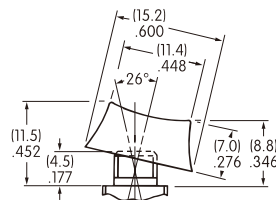
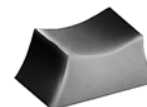

颜色编号:



典型开关尺寸

单极

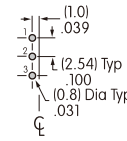
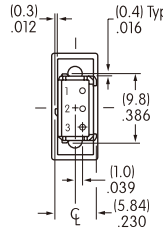
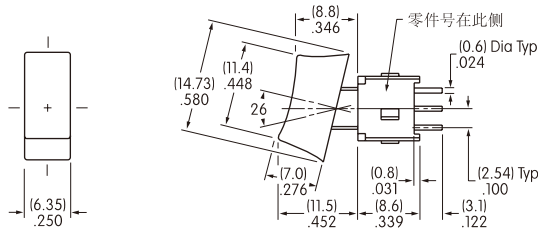

直型PC端子



A12K1P-DA

双极

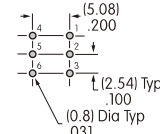
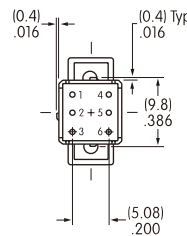
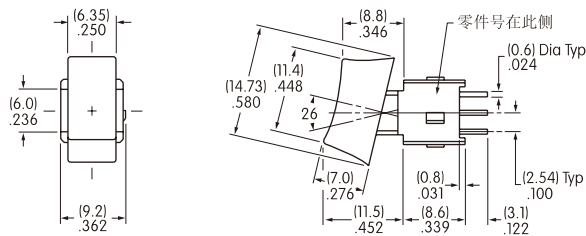

直型PC端子



A22K1P-DA

单极

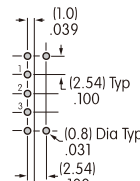
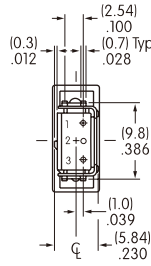
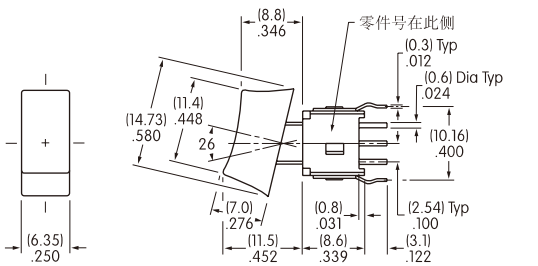

B端子

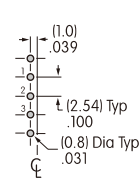

B1端子

直型PC端子·支架



A12K1B-DA

双极

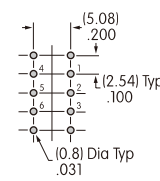
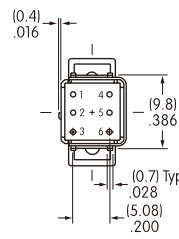
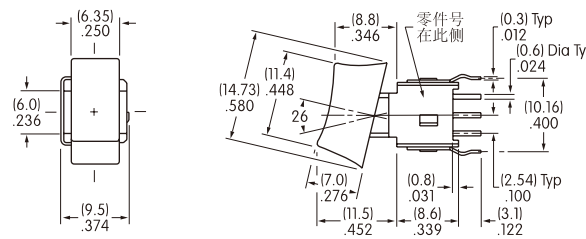

直型PC端子·支架



A22K1B-DA

单极

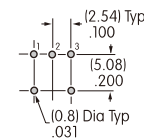
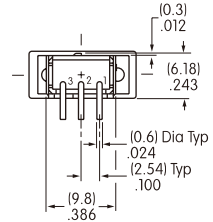
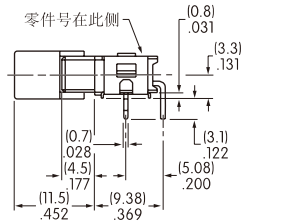
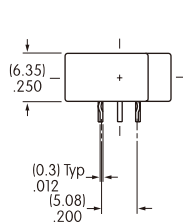

直角型PC端子



A12K1H-DA

典型开关尺寸

直角型PC端子

双极

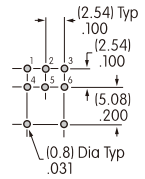
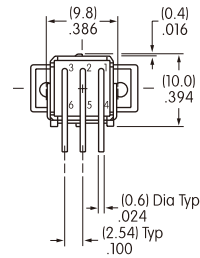
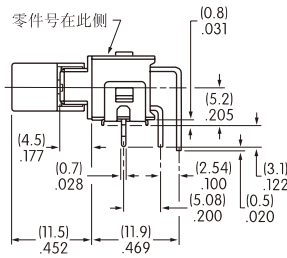
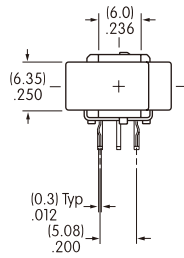

A22K1H-DA

垂直PC端子

单极

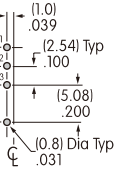
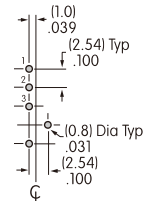
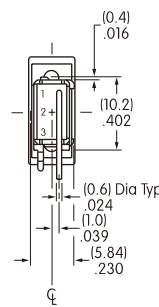
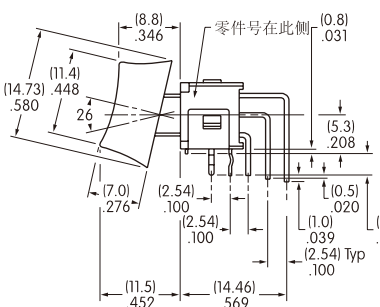
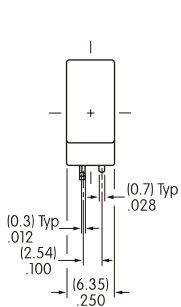

A12K1V-DA

V 端子 V1 端子

垂直PC端子

双极

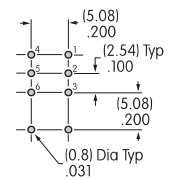
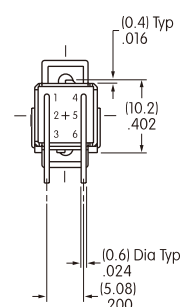
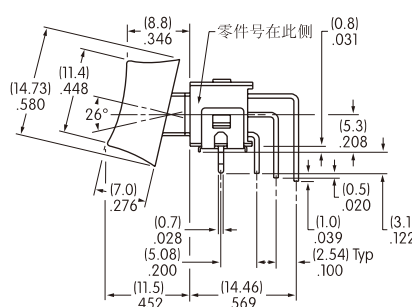
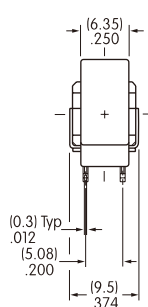

A22K1V-DA

翘板开关安装

配有垂直和直角端子的翘板开关安装时, 开关外壳顶上的印刷电路板的扩展不得干扰翘板的运动, 否则会导致不完全的开关操作。

如下图所示, 印刷电路板允许最大扩展尺寸为: .051"(1.3mm)。

由于配有直角端子的双极开关宽度特别大而且翘板会碰到印刷电路板, 因此, 本注意事项并不适于此开关。

翘板开关的侧视图
直角安装印刷电路板端子
仅适用于单极

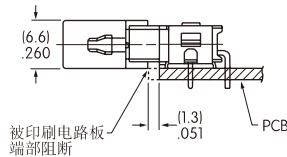

翘板开关的侧视图
垂直安装PC端子
单极和双极

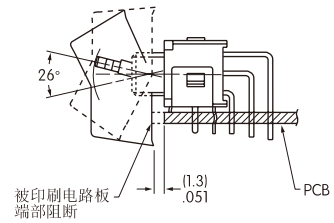

备忘：
