

通用规格

电气容量 (电阻性负载)

微小功率: 最大0.4VA在最大28V AC/DC
(适用范围0.1mA~0.1A在20mV~28V)
注: 请参阅附录中关于运行范围的更多说明。

其他额定参数

触点电阻: 最大50毫欧
绝缘电阻: 500兆欧以上在500V DC
绝缘强度: 最低500V AC至少1分钟
机械寿命: 50,000次操作以上 (瞬间式)
25,000次操作以上 (交替动作)
电气寿命: 50,000次操作以上 (瞬间式)
25,000次操作以上 (交替动作)
标称操作力: 2.55N (瞬间); 2.94N (交替动作)
接触时间点: 无短路
行程: 瞬间式: 预行程.028" (0.7mm); 超行程.016" (0.4mm); 总行程.043" (1.1mm)
交替式: 预行程.039" (1.0mm); 超行程.039" (1.0mm); 总行程.079" (2.0mm)

材质和涂覆

插塞: 聚醛树脂
衬套: 渗碳聚酰胺
外壳: 玻璃纤维增强聚酰胺
支撑支架: 镀锡磷青铜
活动触点: 磷青铜镀金
固定触点: 铜合金镀金
端子: 铜合金镀金

环境数据

工作温度范围: -30°C到+85°C (-22°F到+185°F)
湿度: 96小时内40°C (104°F)时, 湿度90~95%
振动: 用1.5mm峰-峰振幅遍历10~55Hz频率范围, 并在1分钟内返回; 3个直角方向2小时
冲击: 50G (490m/s²) 加速度 (在6个直角方向上测试, 每个方向上5次冲击)

安装

盖帽安装力: 最大49.03N (11.2 lbf)向下施加在操作部上;
操作部必须在UP位置上以便从交替动作端子上拆下盖帽

印刷电路板处理

焊接: 推荐波峰焊: 请参阅附录中的概略图A。
手工焊接: 请参阅附录中的概略图B。
清洗: 自动清洗。请参阅附录中的清洗规格。

标准和认证

易燃性标准: 可供UL94V-0
BB系列按钮开关未经过UL认证或CSA认证的测试。
这些开关为在低电压, 低电流以及微小电流电路下使用而设计。
当按原意图用于微小电流电路时, 其结果不会产生危险的能量。

主要特点

采用超小型尺寸(M系列开关的1/3大小)以节省印刷电路板上的空间。

专为微小电流电路应用而设计。

可用于瞬间式和持续式电路中。

为(实际应用中)最小的带锁定特征的交替动作开关, 给予视觉, 听觉以及触觉上的享受。

采用超抗静电结构, 由渗碳衬套和支撑支架组成, 防止触电静电放电。由于操作人员的接触而产生的静电, 会从操作部通过衬套和支架传导到印刷电路板。

获奖的STC触点装置具有传统触点装置所没有的如下优点: 更加平滑、制动更可靠、触点稳定性更高、及无与伦比的微小功率可靠性。(关于STC的术语和缩写的详情, 参阅附录目录。)

直径为6mm平滑的衬套简化了面板的布局。

全封闭式结构可以防止触点污染并能自动进行焊接和清洗, 从而节省了时间和费用。

.100" x .100" (2.54mm x 2.54mm) 端子间距符合标准印刷电路板的格子间距。

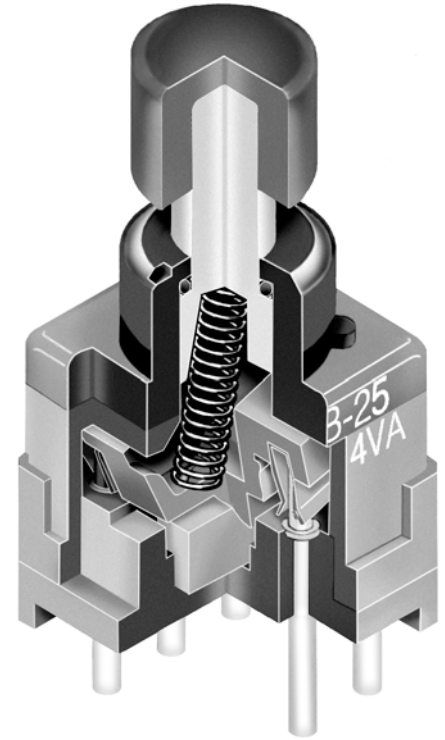

实际尺寸

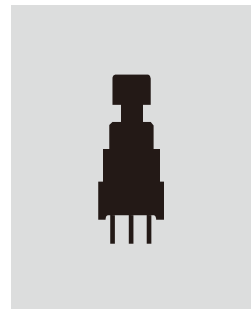

摇头开关

翘板开关

按钮开关

发光按钮开关

可编程开关

钥匙锁开关

旋转开关

滑动开关

触觉开关

倾斜开关

触觉开关

指示灯

附件

附录

典型开关订购举例

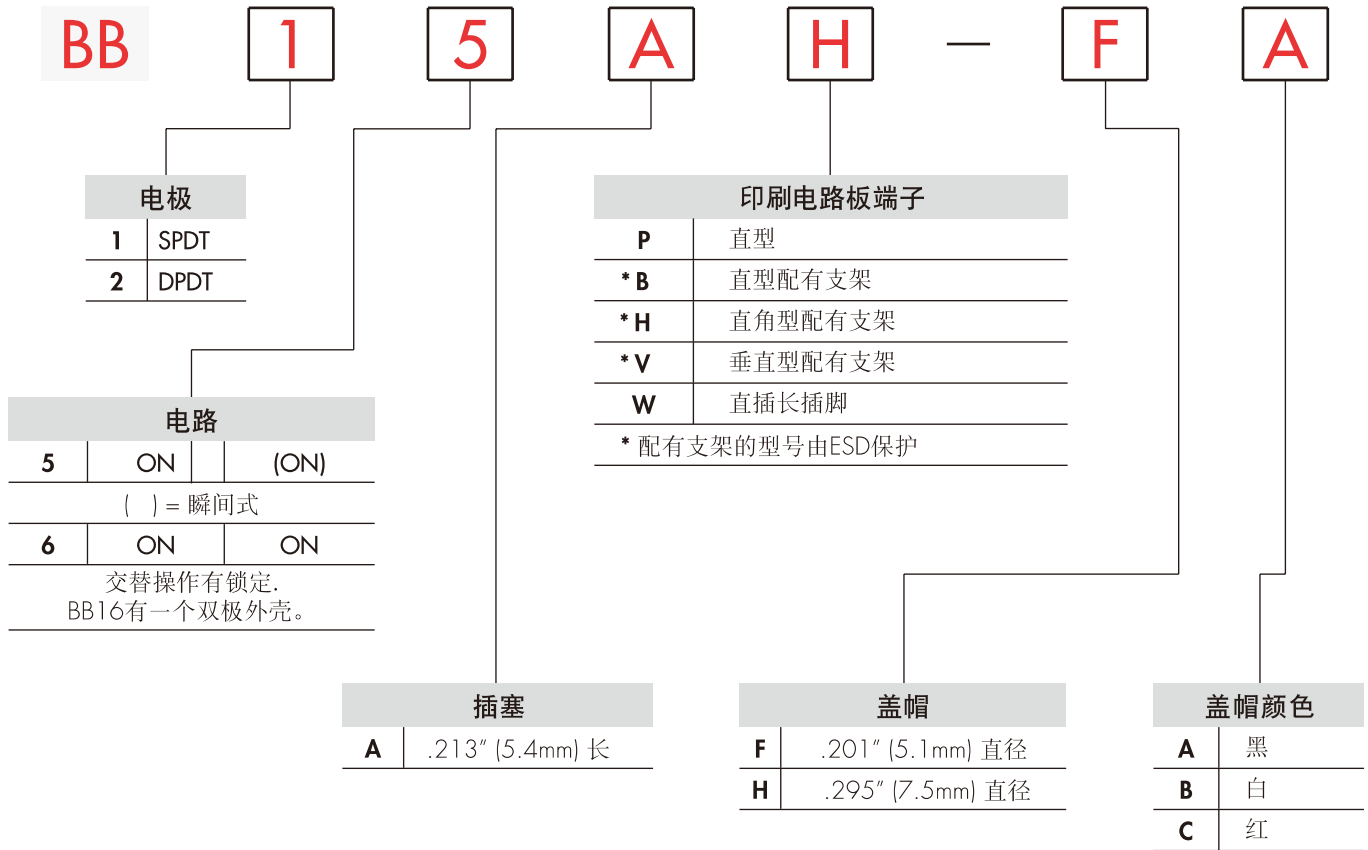



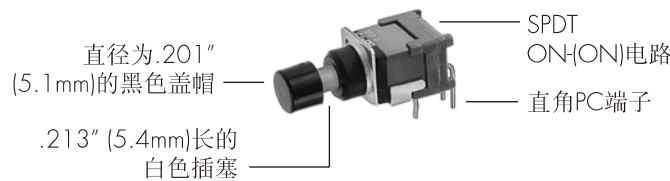

典型订购举例

BB15AH-FA

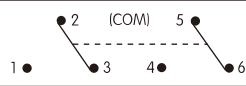

电极和电路

		插塞位置 () = 瞬间式		连接的端子		投掷及其示意图
电极	型号	正常 	下 	正常 	下 	
SP	BB15 BB16	ON ON	(ON) ON	2-3	2-1	SPDT 
DP	BB25 BB26	ON ON	(ON) ON	2-3 5-6	2-1 5-4	DPDT 

注：端子编号并未实际印制在开关上。

插塞

A .213" (5.4mm) 长

标准插塞颜色：白色

欲购其它颜色或长度的插塞请与厂家联系。

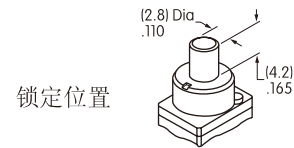
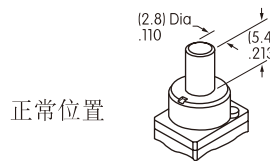

印刷电路板端子

建议使用支撑支架以加强印刷电路板的安装强度和稳定性。

P 直型

单极和双极交替动作型号端子都有双极外壳。

详情请参阅典型开关尺寸一章。

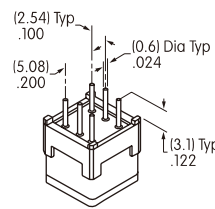

B 直型
配有支架

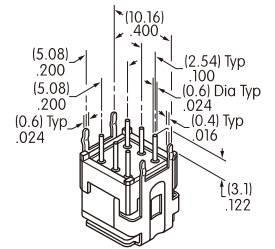

H 直角型配有支架

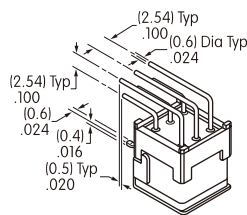

V 垂直型配有支架

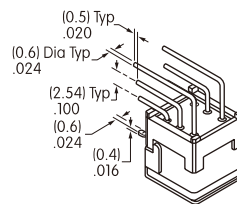

W 直插长插脚

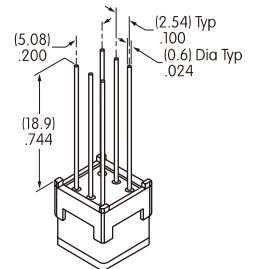

滑入式盖帽

F AT475
直径.201" (5.1mm)的盖帽

材质：聚酰胺

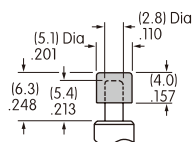

H AT496
直径.295" (7.5mm)的盖帽

材质：聚酰胺

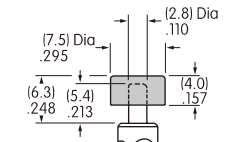

可供颜色：

A 黑

B 白

C 红

典型开关尺寸

直型PC端子

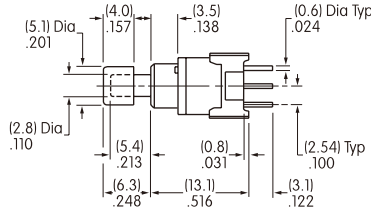
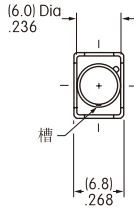

单极

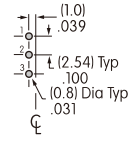
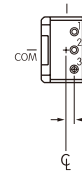

BB15AP-FA

瞬间式

直型PC端子

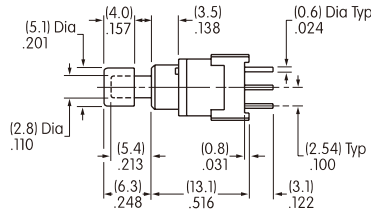
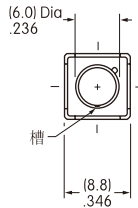

双极

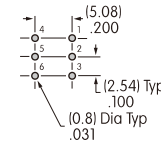
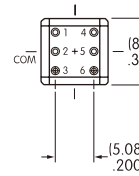

BB16AP

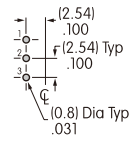
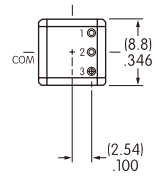

BB25AP-FA

瞬间式和交替式

交替式

直型PC端子·支架

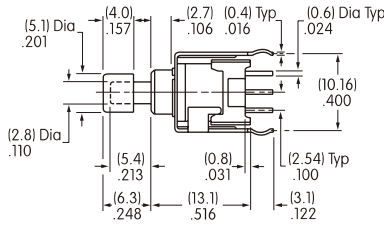
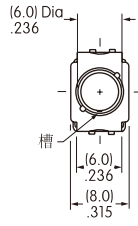

单极

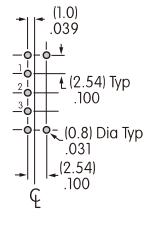
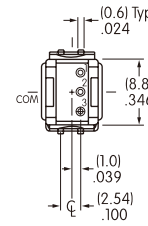

BB15AB-FA

瞬间式

直型PC端子·支架

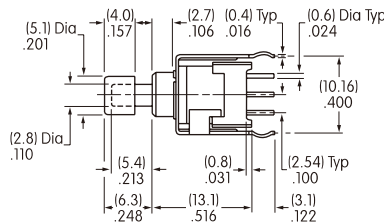
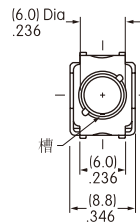

双极

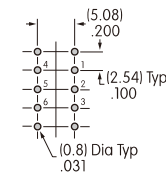
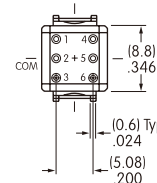

BB16AB

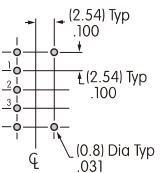
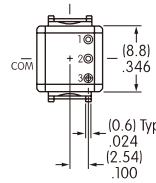

BB25AB-FA

瞬间式和交替式

交替式

摇头开关
翘板开关
按钮开关
发光按钮开关
可编程开关
钥匙锁开关
旋转开关
滑动开关
触觉开关
触觉开关
指示灯
附件
附录

典型开关尺寸

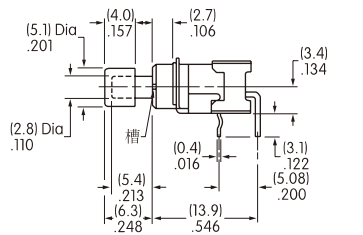
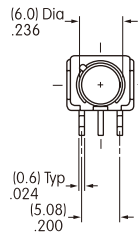

单极

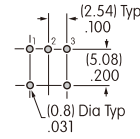
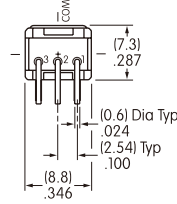

瞬间式

直角PC端子



BB15AH-FA

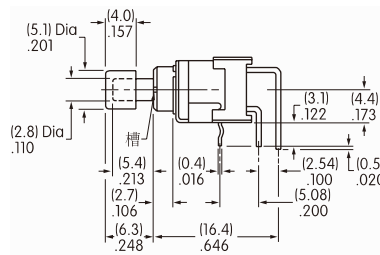
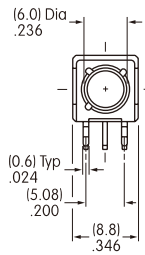

双极

BB16AH

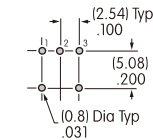
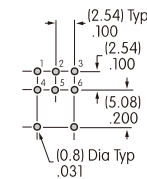
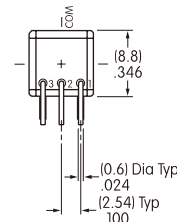
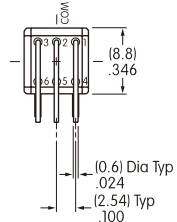

瞬间式和交替式

交替式

直角PC端子



BB25AH-FA

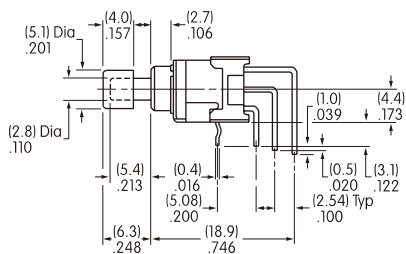
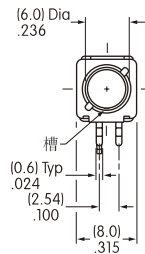

单极

垂直型PC端子

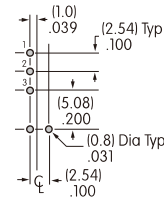
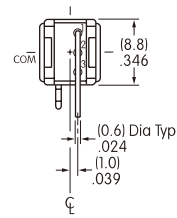

瞬间式



BB15AV-FA

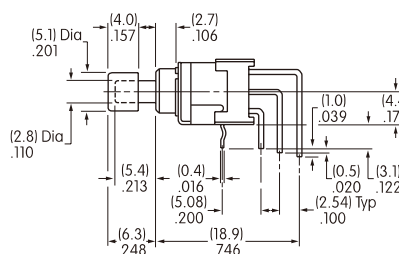
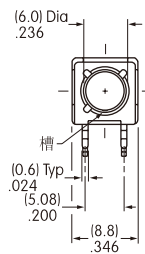

双极

BB16AV

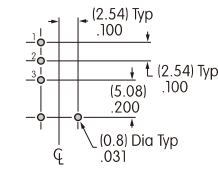
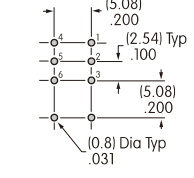
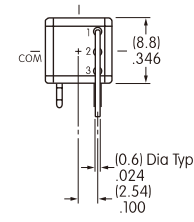
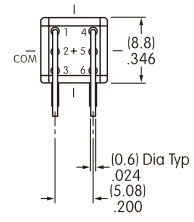

瞬间式和交替式

交替式

垂直型PC端子



BB25AV-FA