

# *The Trouble with Oscilloscope Probes*

## *and an “off-piste” design for microwave and gigabit applications*

*Mark V. Ashcroft*

*Pico Technology Ltd.*

St. Neots, United Kingdom

mark.ashcroft@picotech.com

**Abstract**—The low-cost hand-held oscilloscope probe has changed very little in the last three or four decades. Arguably it has lost touch with its applications as signals have become faster, smaller and more prone to the invasive nature of their measurement. This paper reviews the rapidly growing scale of the problem and proposes a more appropriate design approach to achieve a microwave and gigabit test probe.

**Keywords**—*oscilloscope; test; active; passive; hand-held; browser; logic; probe; microwave; RF; gigabit.*

### I. INTRODUCTION - GIGABIT DATA AND WIRELESS EVERYWHERE

Today we are surrounded by gigabit per second data flow and wireless technologies in our homes, our cars, the workplace and on our person. Our communications, transport, energy, commodities and waste infrastructure all depend on them. Despite this, if we consider our ability to “see” and measure these signals; we are limited in our options and typically face high costs and skill requirements. The location of even quite basic faults typically requires a well-equipped service center or central dealer. The network, media system or security install or service technician; or street corner computer or phone repair shop, typically doesn’t have a multi-channel gigabit instrument and a pack of broadband test probes at their disposal.

High-speed signals are now commonplace, but affordable measurement capability lags well, arguably decades, behind. It seems quite likely that the lack of cost-effective measurement solutions might contribute to a “throw away” mentality.

### II. COULD THINGS GET ANY WORSE ?

Unsurprisingly, the need to view, measure and analyze these high-speed signals really does not abate and the microwave and gigabit community have devised often highly compromised solutions of their own to meet the need.

The key difficulty faced is that high-speed signals travel in matched transmission lines and any conductor (or dielectric) that contacts the line will create mismatch and invade or disturb the measurement. Upon contact, it is quite possible that function of the whole system will be interrupted, in some industries possibly with dire consequences. Almost certainly there will be an unacceptable corruption of the signal that we are trying to measure. Efficient debug of system malfunction is severely hampered if we do not have the ability to “see”, measure and analyze whilst the system under test operates.

Two common microwave and gigabit measurement solutions in use today do not even achieve measurement during system function. A third is often so invasive, or so costly that we often accept mere detection of presence, or capture of the ‘general shape’ of a signal. In doing so, we may threaten ongoing system function in the hope of not quite interrupting it.

#### A. Break into the Signal Transmission Line

Without doubt the method having greatest measurement integrity is to break into the transmission line and route its signal to a correctly matched terminating or ‘sniffing’ measurement instrument. The latter could in some circumstances re-inject the signal back into the system under test, albeit with delay, loss of amplitude or distortions. Most commonly however, a power meter, signal analyzer, or an oscilloscope will terminate the signal and downstream system function is lost.

#### B. Separate Measurement of Individual System components

Similar in integrity and impact to system function is the complete removal of a suspect system component and its measurement as a two or more port network or ‘black box’.

In this case for instance a vector network analyzer will inject a swept sinewave to each port in turn and measure responses at every other port. Perhaps more representative of the now most common real applications is a time domain reflectometer and transmission analyzer or oscilloscope. These will inject a fast pulse to achieve a similar result.

Unfortunately, whilst both approaches do wholly characterize the behavior of our component, neither uses the actual signal from and to the actual port matches of the application. Relating the measurement back to system malfunction is typically a time consuming, highly skilled and error prone interpretation.

The point here is that both of the above measurement solutions require a break into and in most cases halting of signal flow. Perhaps acceptable when high speed signals typically routed via a few connectorized system elements and when multiple parallel data streams were rare. Today however, we have to accept that breaking into multiple parallel coax, twisted pairs and fractional millimeter PCB microstrip is at the very least inconvenient, if not completely impractical!

### C. The Oscilloscope or In-circuit Test Probe

This third measurement probing solution aims to non-invasively measure by contacting a circuit, not breaking into it.

Unfortunately, at microwave and gigabit frequencies, generally this approach comprehensively fails to be non-invasive. It is necessary to expect the best that can be achieved is “low-invasive” or “moderately invasive” probing.

At high frequency, the capacitance or, more accurately, probe tip impedance of these probes is comparable with or falls below that of the probed node or line impedance. A significant mismatch is incurred upon contact; possibly not dissimilar in impact to shorting the signal altogether at many of its spectral components. The typical nature and scale of resulting measurement distortions is illustrated throughout the content below.

In-circuit test probes fall into two groupings, minimizing measurement invasion (essentially their own capacitance) in different ways:

- Passive probes divide or attenuate the signal amplitude as close as possible to the probe tip to transform tip impedance to a higher value. One subgroup does this for the standard input impedance of oscilloscopes at 1 MΩ, another subgroup does this for oscilloscopes or any other measurement instrument having a 50 Ω input port.
- Active probes amplify as close as possible to the probe tip to buffer the probe tip from downstream cable or instrument impedances.
- An active probe may both divide and amplify to optimize tip impedance and dynamic range.

However, amplification and division both incur compromises right behind the probe tip:

- Signal division reduces ever smaller amplitude signals down towards the ever rising broadband noise floor. In practice, division and impedance transformation ratio have to remain small.
- Amplification introduces fragile components, noise, non-linearity and flatness errors and slow recovery from saturation characteristics.

## III. THE NATURE AND SCALE OF OSCILLOSCOPE PROBE SHORTCOMINGS

### A. The Traditional Passive Oscilloscope Probe

Figs. 1 and 2 illustrate the scale of today’s low-cost probing problem. This is a simulation of a high-performance but traditional oscilloscope probe (Divide by 10, 500 MHz bandwidth and 10 MΩ // 10 pF tip impedance)<sup>[1]</sup>. It is probing a 50 Ω transmission line carrying a pulsed-pairs waveform. The three pulse periods here represent common bit intervals at 10, 5 and 1 Gb/s; oscilloscope bandwidth is 1 GHz. A probe of this specification typically sells from around \$200 per channel and it represents just about the limit of this technology.

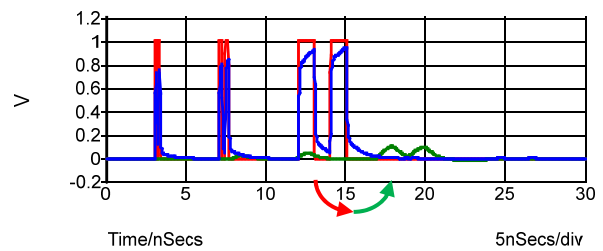

Fig. 1. 10, 5 and 1 Gb/s pulse pairs probed with a traditional 500 MHz oscilloscope probe.

The red trace is that of the unprobed signal. The blue shows the invasive impact of this probe, significant eye closure in all cases and more than enough to threaten disruption of system function at the higher bit rates. The green is the delayed and of course wholly inadequate response from the probe at any of these now common data rates.

Below is the frequency domain response of the probe and the probed signal. Monte Carlo simulation accounts DUT mismatch at both ends of the probed line. The bandwidths of the probe, the oscilloscope and the loading at the probe tip combine to reduce measurement bandwidth below 400 MHz, despite a degree of peaking in the probe. More importantly to ongoing system function, the loading on the line reduces transmitted signal bandwidth to just above 1 GHz in this case.

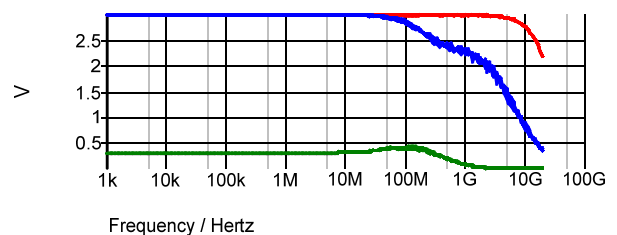

Fig. 2. Frequency response of the standard probe and the probed line.

### B. A Typical 6 GHz Active Oscilloscope Probe

Figs. 3, 4 and 5 show the same responses for a typical 6 GHz active probe. Again a divide by 10 example as these will have the highest tip impedance; in this case specified at 100 kΩ in parallel with 0.9 pF. Oscilloscope bandwidth here is 20 GHz.

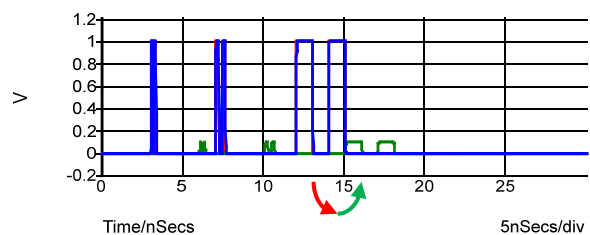

Fig. 3. 10, 5 and 1 Gb/s pulse pairs probed with a 6 GHz active probe.

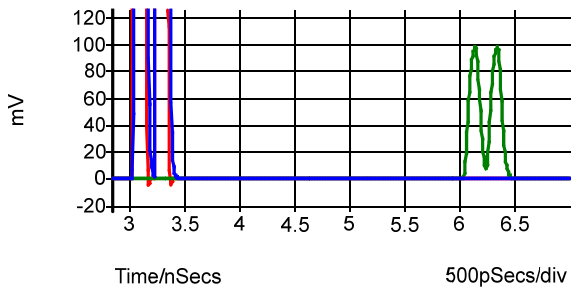

Fig. 4. Zoom of 10 Gb/s pulse pair probed with a 6 GHz active probe.

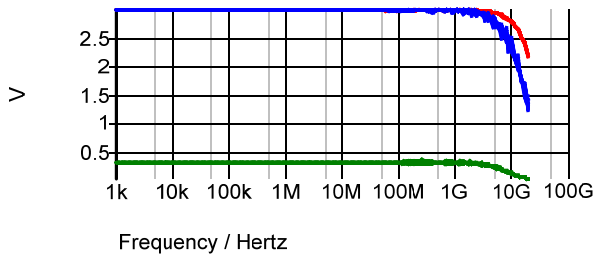

Fig. 5. Frequency response of the 6 GHz active probe and the probed line.

In this measurement bandwidth we can see the 10Gb/s waveform and can expect to be able to characterize up to 2 Gb/s, for which 5<sup>th</sup> harmonic is present in the measurement. Shunt loading of the measurement is reduced here and less likely to disrupt system function at these bit rates; however, downstream bandwidth is reduced to just over 10 GHz and timings (or phase) on the probed line will certainly shift.

Line loading is still a significant contributor to the overall probe and measurement bandwidth, often compensated by peaking the internal amplifier, or more commonly today, s-parameter (S21) correction within a digitizing instrument. Probe bandwidth can be improved by >50%, but naturally, there is no benefit to the downstream impact of the probe tip loading. Given the opportunity to lift bandwidth with corrections it has to be noted that some modern probes have become particularly invasive to the test node!

Active probes between 3 to 30 GHz are typically priced at or above \$1000 + \$1000 / GHz for each channel! Available from just four manufacturers, this 6 GHz probe will cost about \$7000 each, and in most cases will only work with oscilloscopes, from the same manufacturer, possibly only a few models with their range. Many also tend to be rather bulky and heavy relative to the fine geometry and fragile workload!

#### IV. TURNING TO THE LOW-IMPEDANCE PASSIVE PROBE

The low-impedance passive probe is not new; in fact, often in home-made form, it is one of the aforementioned compromised solutions that the RF and microwave community have been using for some time.

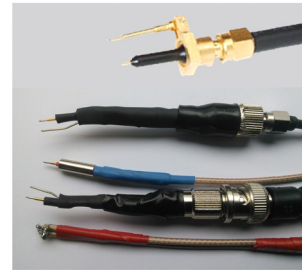

Fig. 6. Examples of high frequency low impedance passive probes in use today, the majority home-made.

The vast majority are simply a resistor, typically 450  $\Omega$ , feeding the open end of a 50  $\Omega$  transmission line that is terminated at the receiving instrument. As can be seen in Fig. 6, a variety of signal ground arrangements are fashioned, and as can be imagined, response and invasion of the measurement are a bit hit-and-miss and not necessarily constant. Nevertheless the principle is sound and allows the user to at least see their high-speed signal within a reasonably high bandwidth. Input impedance in this divide by 10 example is 500  $\Omega$ , shunted largely by the self-capacitance of the resistor to the open line. A path that can cause severe peaking!

#### A. An “off-piste” design for a Low-Impedance Passive Probe

The proposed new probe design (patent applied for) embeds low impedance and tightly defined resistive and capacitive dividers inside a multi-layer low dk microwave printed circuit substrate. In doing so, coplanar components and buried strip-line can achieve high microwave integrity and high isolation electromagnetic screening. Miniature design, mechanical precision and robustness, and high thermal dissipation are all achieved without the cost, bulk and stray capacitance of further metal or supporting enclosure. Critically, by embedding the probe tip between layers at the edge of the PCB, the probe tip is robustly supported by a minimum of near ideal and strong dielectric material.



Fig. 7. Practical realisation of low-cost precision passive probe.

While it is not essential to use both, two outer sprung and removable grounding pins are provided. These can reduce grounding inductance and better couple the signal when used to straddle a transmission line with grounds on either side. In practice, probe tip dimensions are such that lumped inductance and capacitance tend to combine to form a short line of around 150  $\Omega$ ; commensurate with the lower input resistance probe heads in the range, and never an excessive shunt load upon the probed line.

Thanks to the relatively low cost of this realization, interchangeable probe heads can support a range of ratios and AC and DC coupled design; and still remain at lower overall cost than the typical active probe solution. Initially, this format achieves a tip capacitance in the region of 0.3 pF and bandwidths out to 9 GHz when probing a 50 Ω line, typically with ±1 dB flatness to 3 GHz. Below are the now familiar responses for direct comparison with those above.

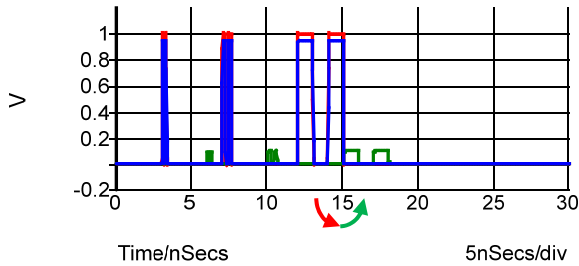

Fig. 8. 10, 5 and 1 Gb/s pulses probed with a 6 GHz low-Z passive probe.

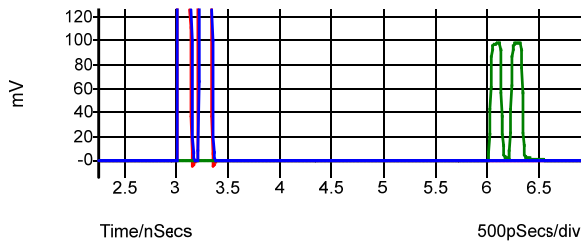

Fig. 9. 10 Gb/s pulse pair probed with a 6 GHz low impedance passive probe

In Figs. 8, 9 (above) and 10 (below) there is clearly a load presented to the probed transmission line as the amplitude of the blue pulses is reduced. However this loss is small and flat to higher frequencies than the heavier capacitive loading of the active probe. It is less likely that this will impact system function during the test. A slight compensation in the division ratio still presents a probe output (green) that is 10x smaller than the unprobed input (red) and this output has full measurement and analysis integrity at least equal to and possibly better than its active counterpart. Monte Carlo simulation shows the mismatch on the line for this largely resistive probe tip is less invasive, certainly at high frequencies, than the active (more capacitive) probe.

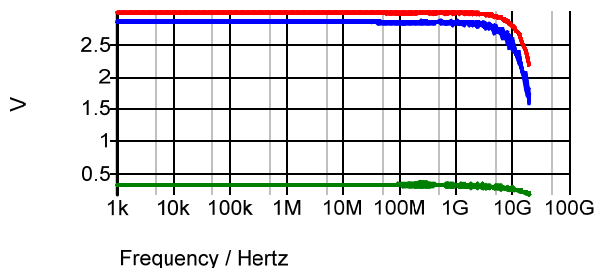

Fig. 10. Frequency response of the 6 GHz passive probe and the probed line.

Hugely in its favor, the end user cost of this passive finger-held test probe sits at around \$100 + \$150 / GHz, and reduces the cost of a 6 GHz probe to around \$1000 per channel!

### B. TDT Evaluation and Production Test of the New Probe.

PicoConnect probe applications tend to be dominated by high-speed logic and pulse / impulse waveforms. Thus Time Domain Transmission measurements have been used to test these probes; both their response and their probing impact upon a transmission line and downstream waveshapes. A classic application for a PicoScope 9311 TDR/TDT sampling oscilloscope, this same method is used in 100% production test of the probes. The test setup is depicted in Fig. 11.

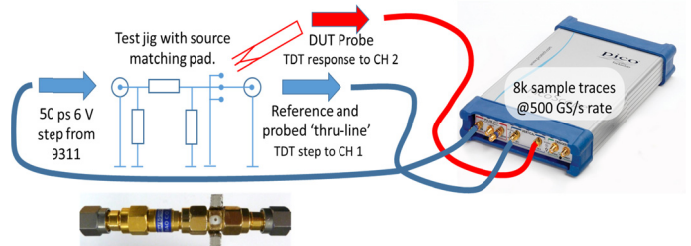

Fig. 11. PicoScope 9311 TDT evaluation & test setup for microwave probes.

A fast step waveform with 50 ps transition time (harmonic content to 13 GHz) is passed through the test jig to CH1 of the sampling oscilloscope. This forms a reference thru on a known good line. When the DUT probe is applied to the line, its loading of the line can be assessed and tip capacitance and resistance determined for the probe.

Temporary connection of the test jig output to CH2 of the oscilloscope allows that path to be corrected for all response errors using the 9311 TDT correction algorithm. The DUT output is then routed and the response of the probe isolated.

Fig. 12 depicts the step response of 50 probe heads across the twelve models (two families, three division ratios and AC or DC coupling). Sampling interval is 2.5 ps, displayed at 500 ps/div and test analysis addresses the first 17 ns of the step (inset); PicoConnect response is “known flat” after this epoch.

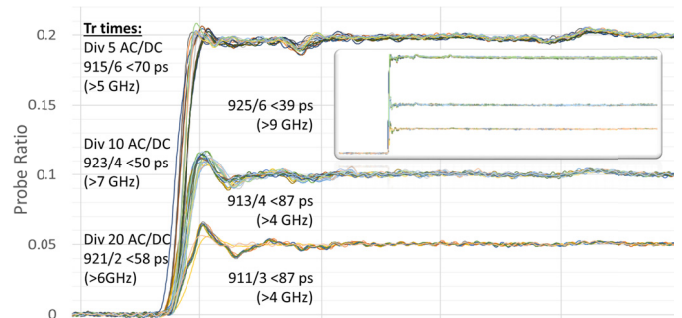

Fig. 12. PicoConnect probe family step responses – First 2 ns (inset 17 ns)

These out-of-the-box responses, deriving from the probe realization, are highly repeatable, with controlled aberrations and very fast settling to long term flat. Pulse, logic and eye fidelity all rely upon these important probe characteristics. Also, having used the TDT correction facilities on the PicoScope 9311 to correct for the test jig, we can note that this



can also be used to correct for any residual probe response when used in a TDT measurement. Likewise, S21 corrections can be used when available on the connected instrument, and both mechanisms are capable of extending probe bandwidth well beyond that specified.

From the monitored thru-line path the impact of the probe on a fast step on the probed line is derived as a difference or error function. All twelve passive probes in the PicoConnect family are represented below.

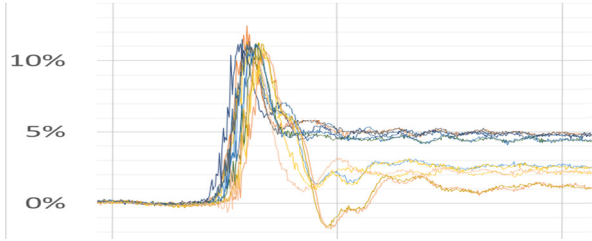

Fig. 13. Loaded line time domain error function (50 ps step, 500 ps/div)

Perhaps the more familiar perspective on line loading is to look at the change in return loss when probing. This shows the loading invasion of PicoConnect probes to lie between -15 to -10 dB; similar or lower than a well-designed active probe, and significantly less than a more typical competitor. Arguably, its -5 dB return loss could be damaging to some signal sources.

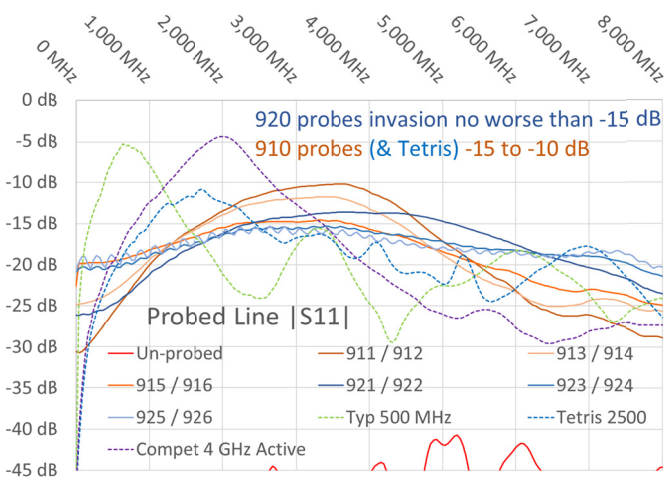

Fig. 14. Changed |S11| due to probing, analysis calibrated to thru line

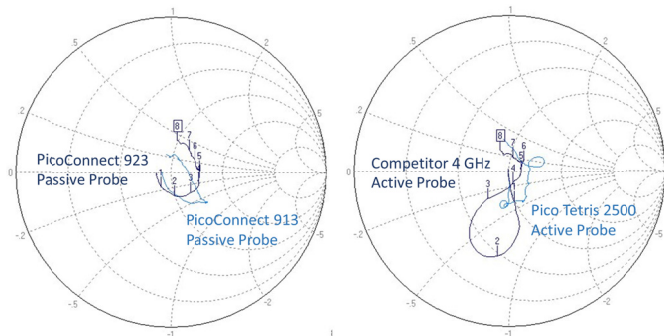

Fig. 15. Probed line S11 as Smith, PicoConnect v Active Probes to 8 GHz

### C. Are there limitations to this Microwave probing approach?

The low-impedance passive probe so far described, with a single relatively high-value resistor feeding the line, does not terminate its coaxial feed to the instrument correctly. This is fine, provided that instrument match is good and multiple signal reflections remain small. Sampling oscilloscopes and signal analyzers generally are well matched; a real-time oscilloscope at this bandwidth may not be. To combat this, or for demanding pulse fidelity applications, a variant probe design adds shunt line match resistance at the probe head output. The impact is that for any given ratio, tip impedance halves loading the line more heavily; susceptibility to DUT mismatches increases and a trade-off ensues.

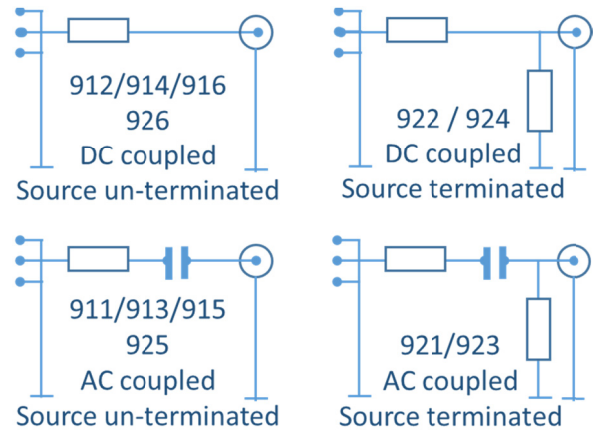

Fig. 16. Four basic configurations of PicoConnect passive probe

Finally with any low impedance passive probe there is a potential division ratio 'gain' error, in that there is a dependence upon actual probed transmission line (source) impedance. The range of line impedances typically encountered is small (45 Ω to 75 Ω single ended) and ratio can be optimized between these values with less than ±3% error across this range. In any event ratio error is calculable if line impedance is known.

Remembering that test node impedance on a transmission line of characteristic impedance  $Z_0$  will be  $Z_0 / 2$ , Fig. 17 plots the actual probe ratio of the above two nominal 10:1 designs.

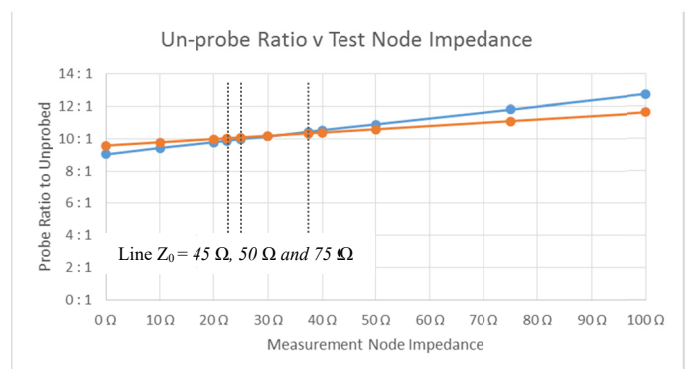

Fig. 17. Ratio dependence upon test node impedance for two low-impedance, nominally 10 : 1, probe designs. 45 Ω, 50 Ω and 75 Ω  $Z_0$  points indicated.

## V. A CONCLUSION THAT THE LOW-IMPEDANCE PASSIVE PROBE SHOULD HAVE ITS DAY

Test and measurement providers have tended to by-pass development of the Low Impedance Passive Probe, used by RF and microwave engineers for decades, as a high-integrity, low-cost, front-line probing solution. Already emerged wireless and gigabit technologies are desperately in need of the solution, and for it to be widely proliferated for application throughout product life-cycles and across user skill sets. This paper concludes that the humble Low Impedance Passive Probe does provide a credible answer.

The design approach has initially realized interchangeable probe heads with bandwidths out to 9 GHz, ratios of divide by 5, 10, and 20 at tip impedances between 220 and 910  $\Omega$ ; DC, or AC coupled (down to 100 kHz). These probes are suitable for use with any 50  $\Omega$  terminating measurement port, trigger or clock input. They are suited to application with oscilloscopes, signal analyzers, TDT and network (transmission) analyzers, timer-counters and millivolt meters, and without regard to manufacturer. Tight tolerance and coplanar manufacture within a multilayer microwave PCB substrate has achieved high measurement integrity in the probed waveform.

Above all, low input capacitance is always less invasive to the measurement and to downstream system performance. Moreover, with attention to dimensions at the probe tips and their coupling to the line, that lower probe tip capacitance combines with smaller coupling inductance to present a more

resistive shunt loading. Measurement bandwidth and downstream impact both benefit.

Perhaps counterintuitively, the paper demonstrates that a low-impedance probe tip can be less intrusive to microwave and gigabit measurements than an equivalent supposedly high-impedance active probe. Naturally the passive probe can be realized at very much lower cost and size than its active counterpart and it will outperform in terms of noise and stability. The output cable is also much lighter and more flexible when manipulating or soldering to fine-pitch circuitry.

Lower cost facilitates the flexibility of interchangeable probe heads and multipoint probing becomes a cost-effective option. The inputs, the outputs, the supply decoupling of a device or subsystem can all be probed using a single family of probes. For instance, high-speed differential logic and supplies around an FPGA; or input, output, envelope modulation and bias or supplies around a power amplifier.

Further advantages are that while there is a limit to the voltage (actually average power) that can be applied to a passive probe (5 to 14 V DC or AC pk in the first realizations) the approach is inherently linear (non-distorting) and does not suffer from saturation or slow recovery phenomena. The passive probe is also inherently EMC robust, it is not fragile in the presence of static or high slew rate and it even offers some protection to a vulnerable instrument. The initial probes are protected and perform to peak applied voltage of between 25 and 150 V pk.

## ACKNOWLEDGMENT

The author acknowledges the contribution of Merlin Circuit Technology (Wales UK) Ltd. and particularly Matthew Beadle in the complex fabrication of the discussed printed circuit board.

Also the contribution of contract electronics manufacturer Circuit Solutions (Cambridge UK) Ltd. and particularly Paul Edmonson for their innovative development of in-PCB surface mount assembly.

## REFERENCES

- [1] D. Ford, "The Secret World of Oscilloscope Probes." Silicon Chip Magazine, Oct 2009, Silicon Chip Publications Pty Ltd.

## PATENT

- [2] UK Patent Application Number 1608829.6 "Microwave and Gigabit Signal Probe".