



EVERLIGHT ELECTRONICS CO.,LTD.

Device Number : CDLE-020-493 REV.: 1

3.0mm Multi-Color Round Type LED Lamps

PART NO. : 209SURSYGW/S530-A3/R2 ECN : _____ Page: 2/5

Absolute Maximum Ratings at Ta = 25°C

Parameter	Symbol	Rating	Unit
Forward Current	IF	SUR 25	mA
		SYG 25	
Operating Temperature	Topr	-40 to +85	°C
Storage Temperature	Tstg	-40 to +100	°C
Soldering Temperature	Tsol	260 ± 5	°C
Electrostatic Discharge	ESD	SUR 2000	V
		SYG 2000	
Power Dissipation	Pd	SUR 60	mW
		SYG 60	
Peak Forward Current (Duty 1/10 @ 1KHz)	IF(Peak)	SUR 160	mA
		SYG 160	
Reverse Voltage	VR	5	V

Electronic Optical Characteristics :

Parameter	Symbol	Min.	Typ.	Max.	Unit	Condition
Luminous Intensity	Iv	SUR 1.00	2.00	/	mcd	IF= 20 mA
		SYG 1.00				
Viewing Angle	2θ 1/2	/	80	/	deg	IF= 20 mA
Peak Wavelength	λ p	SUR /	632	/	nm	IF= 20 mA
		SYG /				
Dominant Wavelength	λ d	SUR /	624	/	nm	IF= 20 mA
		SYG /				
Spectrum Radiation Bandwidth	Δ λ	SUR /	20	/	nm	IF= 20 mA
		SYG /				
Forward Voltage	VF	SUR /	2.0	2.4	V	IF= 20 mA
		SYG /				
Reverse Current	IR	/	/	10	μ A	VR= 5 V



3.0mm Multi-Color Round Type LED Lamps

■ Typical Electro-Optical Characteristic Curves:

< SUR >

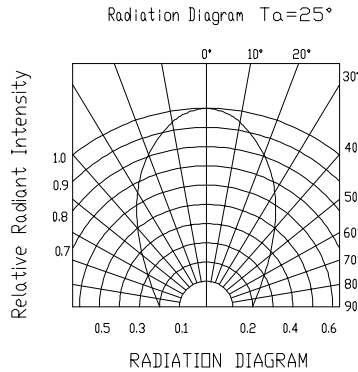
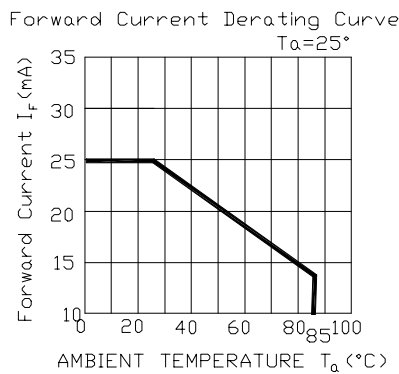
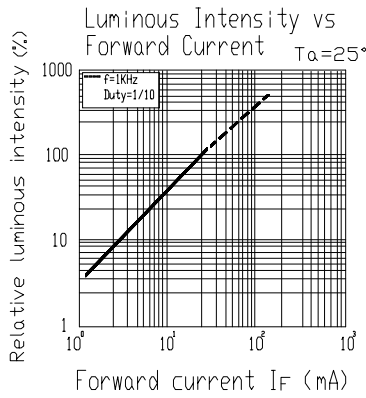
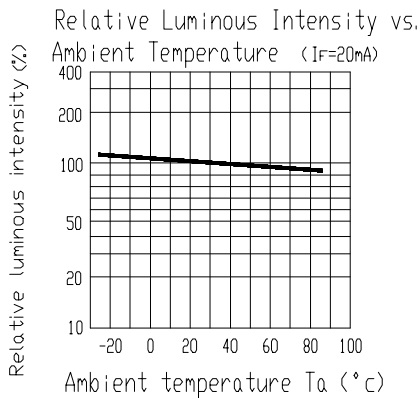
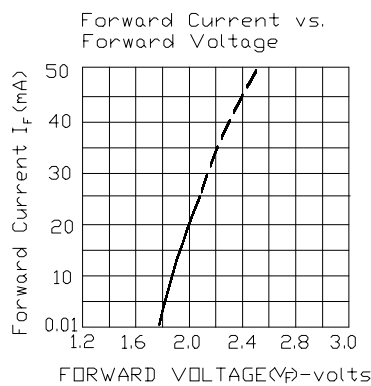
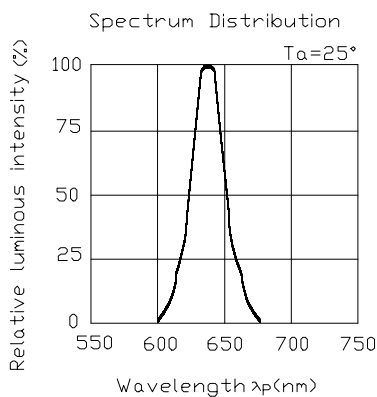



EVERLIGHT ELECTRONICS CO.,LTD.

Device Number : CDLE-020-493 REV.: 1

3.0mm Multi-Color Round Type LED Lamps

PART NO. 209SURSYGW/S530-A3/R2 ECN : _____ Page: 1/5

■ Features :

- Two chips are matched for uniform light output, wide viewing angle
- Long life-solid state reliability
- I.C. compatible/Low power consumption

■ Descriptions :

The 209 LED lamp contain two integral chips and is available as both bicolor and bipolar types.

- The Super Red and Super Yellow Green light is emitted by diodes of AlGaInP and AlGaInP respectively.
- Type of bipolar lamps are both Water Clear and Lens Color while the bicolor are White Diffused

■ Applications :

- TV set
- Monitor
- Telephone
- Computer

■ Package Dimensions:

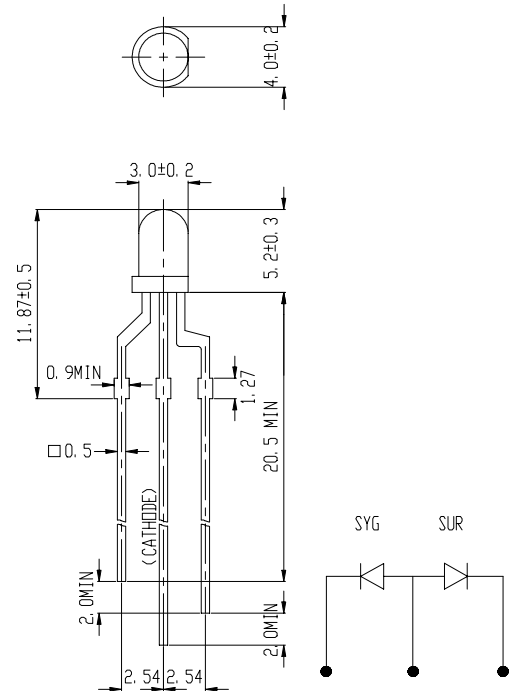

■ Notes :

1. All dimensions are in millimeters.
2. An epoxy meniscus may extend about 1.5mm(0.059") down to the lead.
3. Tolerances unless Dimension ± 0.25 mm.

PART NO.	Chip		Lens Color
	Material	Emitted Color	
209SURSYGW/S530-A3/R2	AlGaInP	Hyper Red	White Diffused
	AlGaInP	Super Yellow Green	



EVERLIGHT ELECTRONICS CO.,LTD.

Device Number : CDLE-020-493 REV.: 1

3.0mm Multi-Color Round Type LED Lamps

PART NO. : 209SURSYGW/S530-A3/R2 ECN : _____ Page: 4/5

Typical Electro-Optical Characteristic Curves:

(SYG)

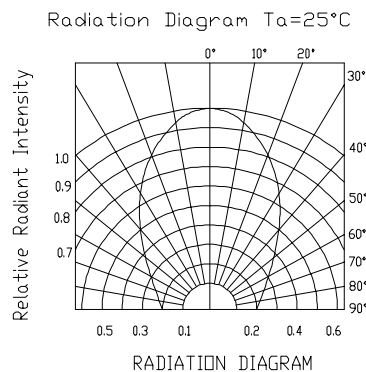
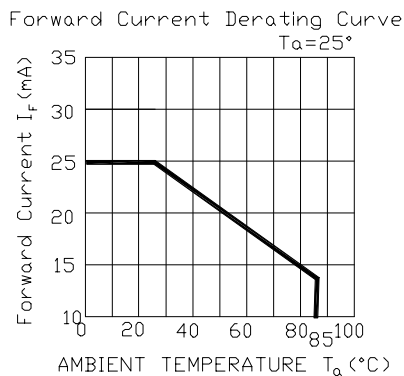
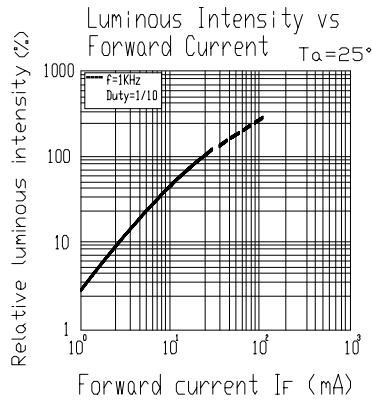
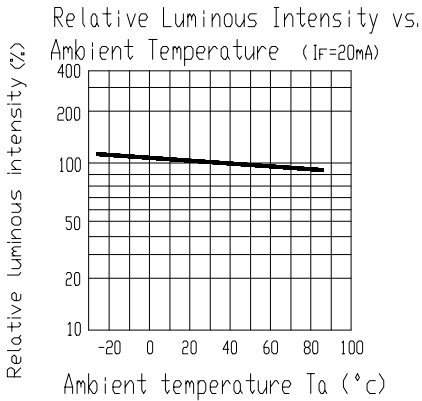
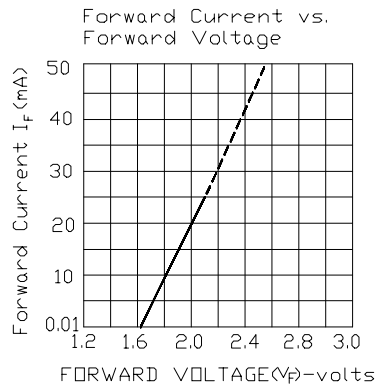
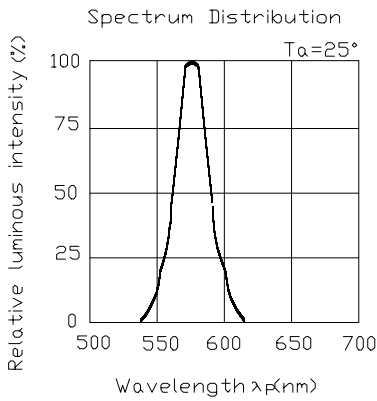



EVERLIGHT ELECTRONICS CO.,LTD.

Device Number : CDLE-020-493 REV.: 1

3.0mm Multi-Color Round Type LED Lamps

PART NO. : 209SURSYGW/S530-A3/R2 ECN : Page: 5/5

■ Reliability test items and conditions:

NO	Item	Test Conditions	Test Hours/Cycle	Sample Size	Ac/Re
1	Solder Heat	TEMP : 260°C ± 5 °C	5 SEC	76 PCS	0/1
2	Temperature Cycle	H : +85°C 30min ∫ 5 min L : -55°C 30min	50 CYCLES	76 PCS	0/1
3	Thermal Shock	H : +100°C 5min ∫ 10 sec L : -10°C 5min	50 CYCLES	76 PCS	0/1
4	High Temperature Storage	TEMP : 100°C	1000 HRS	76 PCS	0/1
5	Low Temperature Storage	TEMP : -55°C	1000 HRS	76 PCS	0/1
6	DC Operating Life	TEMP : 25°C IF = 20 mA	1000 HRS	76 PCS	0/1
7	High Temperature / High Humidity	85°C / 85% RH	1000 HRS	76 PCS	0/1